



Thinking solutions.

## Hot water storage tanks



Storatherm Aqua, Storatherm Heat

# Reflex— a powerful brand for decades

Reflex Winkelmann GmbH—part of the Building+Industry division—is a leading provider of high-quality heating and hot-water supply technology systems. Under its Reflex brand, the company, which has its headquarters in Ahlen in the German region of Westphalia, develops, produces and sells not only diaphragm expansion vessels, but also innovative components and holistic solutions for pressure maintenance, water make-up, degassing and water treatment, storage water heaters and plate heat exchangers, as well as hydraulic manifold and vessel components. Reflex Winkelmann GmbH has over 1,500 employees worldwide, giving it an international presence in all major markets.

With its energy-efficient and sustainable products, the company is already doing its bit to help the environment, as evidenced by its commitment to sustainability and the climate policy goals agreed by the German Federal Government. This support is built on proven technologies and future-oriented innovations. What's more, Reflex Winkelmann GmbH works together with others as equals, always maintains its focus on the customer and offers additional services such as its own factory service centre fleet and a comprehensive range of training options.



# Contents

<b>Reflex City</b>	p. 4
<b>Hot water storage tanks</b>	
Hot water storage tanks from Reflex	p. 6
Energy efficiency that meets the standard	p. 8
my-PV	p.12
Product overview	p.16
<b>Potable water storage tanks</b>	
Key benefits	p.18
Design, function, application	p.19
Storatherm Aqua	p.22
Storatherm Aqua Solar	p.26
Storatherm Aqua Heat Pump	p.34
Storatherm Aqua Compact	p.38
Storatherm Aqua Load	p.44
Storatherm Aqua Inox	p.46
Selection and calculation	p.48
Typical installations	p.53
<b>Buffer storage tanks</b>	
Key benefits	p.58
Design, function, application	p.59
Storatherm Heat	p.60
Storatherm Heat Combi	p.63
Selection and calculation	p.66
Typical installations	p.70
Customised designs	p.72
<b>Accessories</b>	p.73
<b>Reflex Solutions</b>	p.78
<b>Services</b>	p.80
<b>Glossary</b>	p.82

# Reflex City

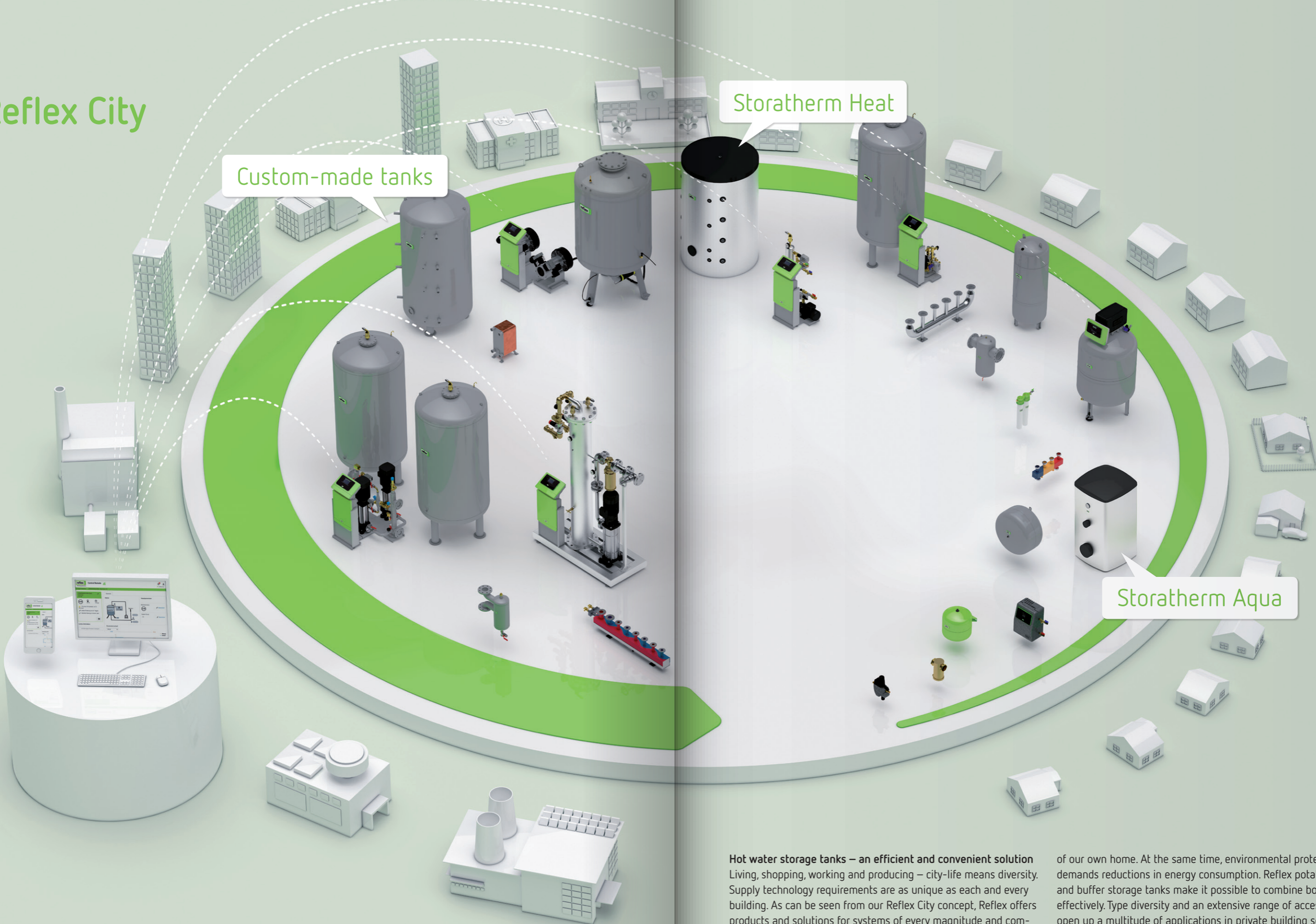

Storatherm Heat

Custom-made tanks

Storatherm Aqua

**Hot water storage tanks – an efficient and convenient solution**  
 Living, shopping, working and producing – city-life means diversity. Supply technology requirements are as unique as each and every building. As can be seen from our Reflex City concept, Reflex offers products and solutions for systems of every magnitude and complexity, ranging from 5 kW systems for a detached home through to safety-related cooling systems for a data centre. Expectations are growing constantly when it comes to the comfort

of our own home. At the same time, environmental protection demands reductions in energy consumption. Reflex potable water and buffer storage tanks make it possible to combine both aspects effectively. Type diversity and an extensive range of accessories open up a multitude of applications in private building services, public buildings and industry – always with the aim of creating hot water solutions that are convenient and efficient.

# Hot water storage tanks

## Potable water storage tanks

## Buffer storage tanks

Storatherm Aqua

Storatherm Heat

Storatherm Heat Combi

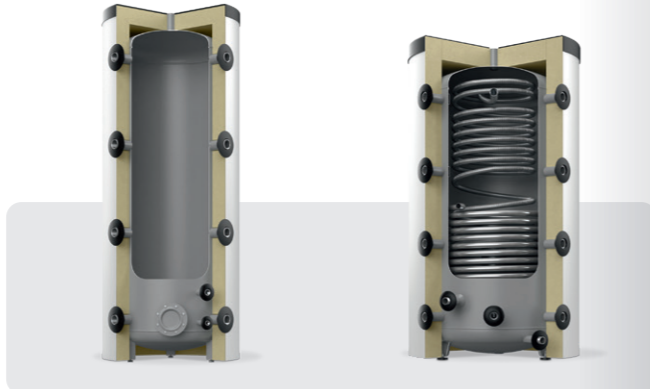
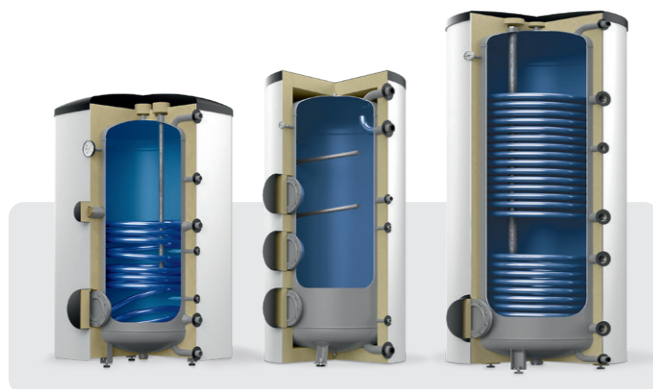

### Storatherm Aqua for storing and heating potable and service water

Differing hot water requirements and heating system configurations with several and in many cases also renewable energy sources call for specific hot water storage tanks for each application, such as standard tanks, tanks for the use of solar energy, tanks for use in heat pump systems or in tank primary store systems. And since the hygiene of potable water always plays a key role in the process, strict guidelines must be observed.

### Storatherm Heat for storing heating and cooling water

Buffer storage tanks separate heat generation and heat consumption both in terms of time and hydraulically. This satisfies a substantial precondition for the demand-driven and efficient provision of energy from waste heat, solar systems, CHP and other heat generators, where heat emission is not directly geared to demand. The Storatherm Heat Combi is both a buffer storage tank and a hot water storage tank, meaning it can be used for hot water preparation and backup heating.



### Manufacturer's certificate for storage water heaters

We hereby confirm that the storage water heaters referred to below are manufactured in accordance with EN 12897:2006. Enamelling work is executed in accordance with DIN 4753-3:2011. Welding work is executed in accordance with DIN EN 287-1:2011 and DIN EN ISO 3834-2:2006. The KTW recommendations and the requirements of DVGW Code of Practice W 270 are complied with. Tanks comply with the technical requirements of Article 3(3) of the EU's Pressure Equipment Directive (2014/68/EU).

### Standards and regulations

Tanks comply with the EU's Pressure Equipment Directive (2014/68/EU). In accordance with the technical requirements under Article 3(3); heating coil: Article 3(2.2) (Annex II, table 9).

## Precision and quality

Reflex Winkelmann is one of the largest manufacturers of hot water storage tanks in Europe. Manufactured with precision and efficiency, the tanks are supplied under our Reflex brand to the trade and end users, as well as to other industry partners in the OEM segment. From prefabrication of the shell across pipe weld-

ing and enamelling through to cladding and final assembly, the highest quality standards apply to the production of the storage tanks at the Legnica plant in Poland. Based on modern aspects, the high-performing production chain is structured in an eco-friendly, sustainable manner.

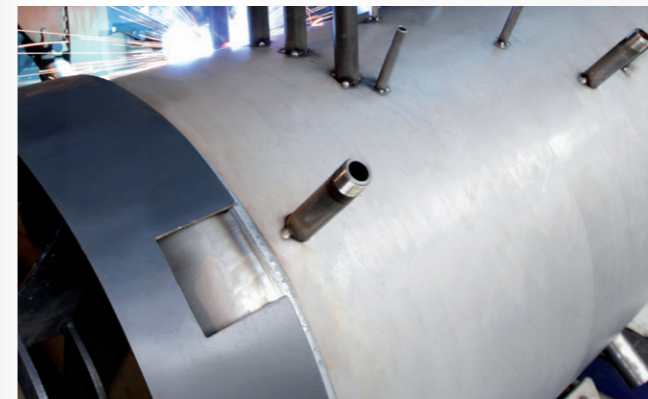

7,600 tonnes of steel are processed there each year for shells and a further 4,200 tonnes are used for the production of pipes with a total length of some 3,400 kilometres. Our own steel trading activities put us in direct and personal contact with dealers—so as to always be in a position to guarantee the highest material quality.

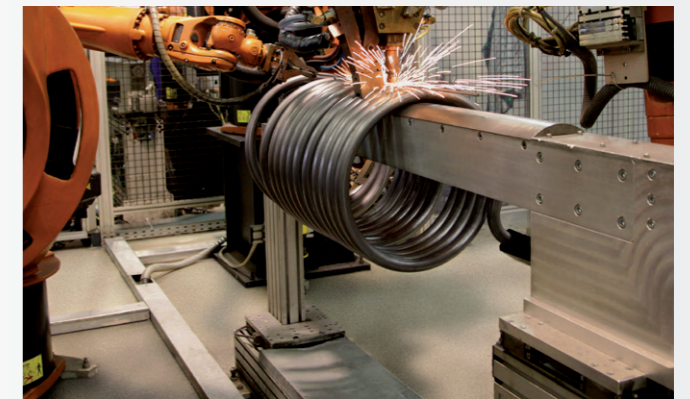

Welding systems and 3D plasma torches ensure tool-free processing and the elimination of 5,000,000 MAG welding spots executed manually.

## Our test facility for your quality

A multitude of test stations allow us to review and improve on the high quality of our tanks continuously, where particular focus is placed on low heat losses, as determined and monitored in the TÜV-certified test facility in accordance with EN 12897:2006. New developments are also examined for efficiency and effectiveness in our test facility.

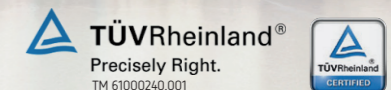

# Energy efficiency that meets the standard

## Introduction of the label

The starting point is the implementation of an EU directive, according to which energy efficiency product labelling has been introduced in heating technology, too, since autumn 2015. In addition to the labelling obligation, minimum energy requirements are also set for certain products, including boilers, heat pumps, solar systems, room heating devices, water heaters and hot water storage tanks. All the storage heaters from the Reflex range with a nominal volume less than 500 litres must display the relevant label. In addition to the efficiency class, the energy label displays a hot water storage tank's standing losses and tank volume. Subject to legal limitations, the standing losses are a tank's losses in output at a certain ambient temperature and measured in watts. Classification to an efficiency class depends on the tank volume.

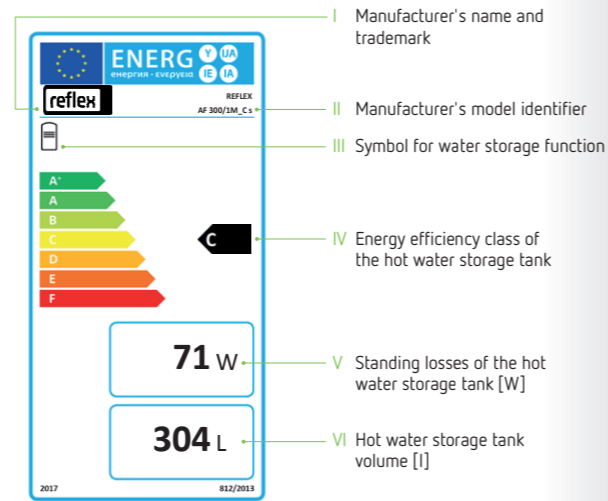

Product label for hot water storage tank

## When and for which products does the label obligation apply?

26/09/2015	Introduction of label obligation and compliance with minimum requirements.
26/09/2017	Tightening of minimum requirements and elimination of the lower classes (e.g. as from 26 September 2017, tanks must be classified to efficiency class C at minimum).
26/09/2017 – 26/09/2019	Stricter minimum requirements in all areas of heating technology. For example, the thresholds for nitrogen oxide emissions from heat generators are reduced.
2016 – 2018	A revision of the EU regulations is planned in order to steer a continuation.

As a general rule, heat generators are compared based on primary energy consumption. This is not necessarily indicative of the future user's energy cost, as the different energy sources are also compared.

## Package or system label

The manufacturer may issue and display package labels in advance if it is able to offer all components as a complete package. Qualified professionals may refer to the manufacturer's package label in such cases when making an offer or sale. If a package sourced from various manufacturers is offered for sale, then the heating contractor must determine the energy efficiency class of this package independently based on the energy performance data of the components and inform the end user of this in the offer. Unlike product labels, package labels contain every energy efficiency class (from G

to A++). All relevant components of a package are listed in system labels. Accordingly, their appearance can differ. Every system label has two columns. The left-hand column is divided into two boxes which indicate the components installed and the energy classes of the products for which a labelling obligation exists. An arrow in the right-hand column of the label marks the energy efficiency class of the entire package.

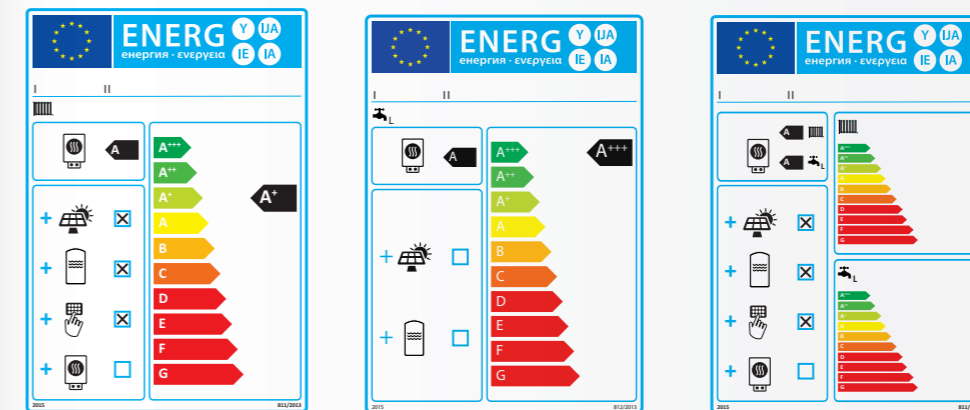

A package's system efficiency label for space heating, hot water preparation and combination heating function

## The Reflex ErP app provides digital support



### Creating the package or system label

As soon as a heating device is replaced and another component installed (such as a solar device or temperature controller), a system label displaying the energy efficiency class must be created for the package as early as during the offer phase. Since the ErP Directive came into force in September 2015, Reflex has provided the help needed to calculate system energy efficiency classes digitally and thus in the simplest way possible. Package labels for systems with components from various different assemblies and modules can be determined and created using the app. These include potable water systems, heating systems, or combinations of the two. Using the app you can ensure the data needed for energy efficiency are available in real time—separately and clearly based on building situation, devices to be installed and budget specified. Needless to say, the timeliness of the data is always ensured through regular updates over the Internet. Our Reflex ErP

app is connected to the portal of the Association of the German Central Heating Industry (VDZ) via an interface, thus providing access to the product data of all manufacturers registered with the portal.



# rECOflex®

## The insulation that makes the difference!

ENERGY EFFICIENCY CLASS

**C**

Heat loss capacity

**80** W

this corresponds to

**1,92** kWh/d

Energy costs to compensate heat losses

**210** €/a

based on energy costs (electricity) of 0,3 €/kWh

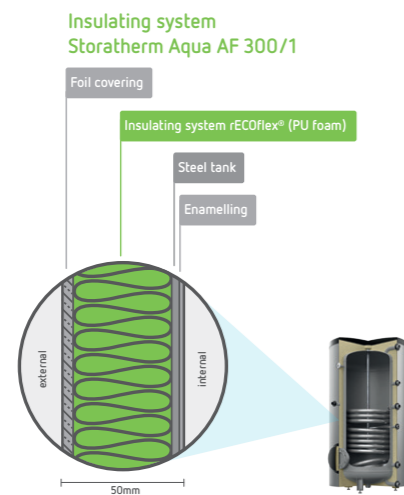

ENERGY EFFICIENCY CLASS

**B**

Heat loss capacity

**57** W

this corresponds to

**1,37** kWh/d

Energy costs to compensate heat losses

**149** €/a

based on energy costs (electricity) of 0,3 €/kWh

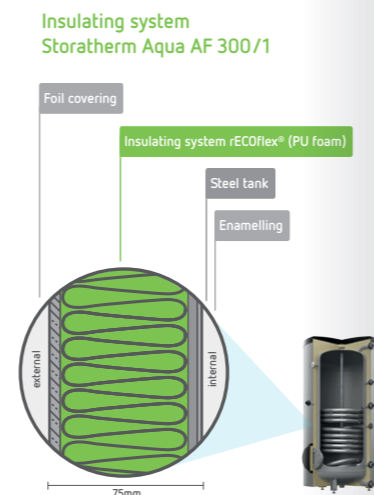

ENERGY EFFICIENCY CLASS

**A**

Heat loss capacity

**49** W

this corresponds to

**1,18** kWh/d

Energy costs to compensate heat losses

**129** €/a

based on energy costs (electricity) of 0,3 €/kWh

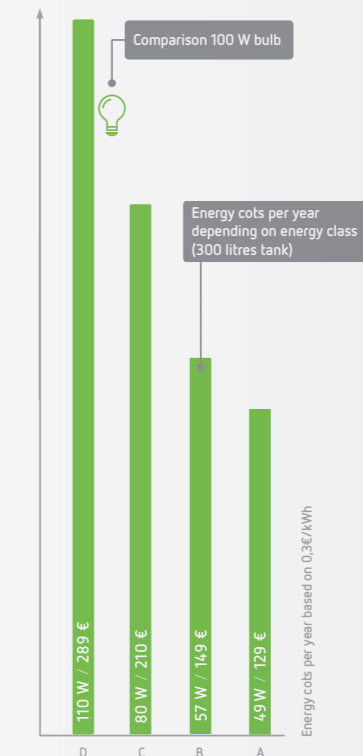
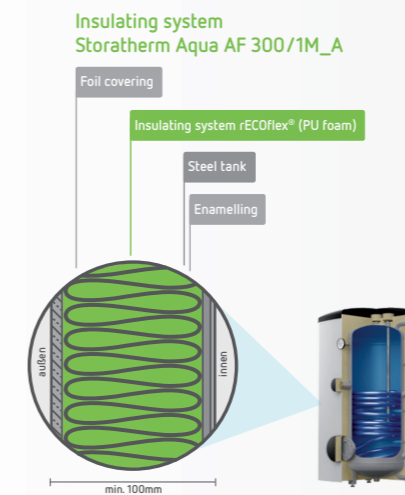

To meet the high requirements, we make sure the products have low standing losses. Various heat insulation strategies can be applied to achieve this. The above figure shows how all the energy-efficiency-class (i.e. C, B and the maximum Class A for potable water storage tanks ≤ 500 litres) market requirements can be met using different construction and heat insulation strategies. Different insulation thicknesses and materials are selected. However, the economic aspect also plays an important role, especially with regard to investment costs for the overall system. The figure illustrates how strongly the various classes of tank differ and the extent to which the use of a higher-class tank can pay off financially. Although the investment costs for a tank with a better energy class are higher, its purchase usually pays off after just a few years of use. Not all tanks can meet the maximum requirements because the standing losses, from which the efficiency class is calculated, depend on various factors:

1. Geometry of the tank (tank volume)
2. Temperature difference between tank and ambient air
3. Type and position of heat insulation
4. Number, type and position of connections

Since some tanks are used very extensively and therefore have multiple connections, achieving the highest efficiency class while at the same time keeping the initial outlay within an acceptable limit for the end user poses a challenge. Our innovative rECOflex® heat insulation system plays an indispensable part in realising the energy efficiency classes shown.

### What are the benefits of Class A?

The higher the energy efficiency class, the better the heat insulation and therefore the lower the heat loss. Both the material thickness and the exceptional quality of the rECOflex® insulation have a direct impact on the efficiency class. It means that consumers have the option to choose between the initial outlay and cutting energy consumption and thus cost. Our Reflex hot water storage tanks are available in efficiency classes A, B and C, meaning all the ErP Directive's requirements are accounted for.

### What sets rECOflex® apart from other insulating materials?

The rECOflex® PU rigid foam has a closed-pore structure, is CFC free and forms a large number of tiny, microscopic cells during the production process. The cell walls are so thin that thermal conductivity is reduced considerably. rECOflex® envelops the tank container completely to prevent heat losses to the greatest possible extent.

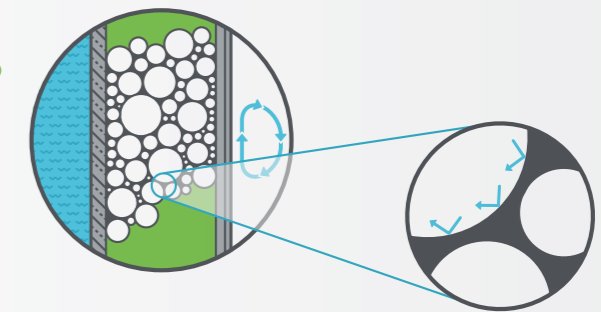

Example:  
Energy cost per year subject to energy class to compensate for the energy losses of a 300-litre storage tank. Energy cost of a 100 W bulb shown for comparison.

# New at Reflex: Power to Heat

## Heat generation using solar power with electric heating elements

Hot water and heating from photovoltaics is a new concept. Historically, electricity was viewed negatively as a source of heat – too valuable, too expensive, too much CO<sub>2</sub>. Things have changed. Now costing less than half in relation to electricity from the grid, electricity from photovoltaics forms the basis. A household can only consume a small share of the solar power produced by photovoltaic (PV) systems. Installing electric heating elements in a hot water storage tank enables a household to use excess solar energy to heat its water – and optimises its energy consumption by means of intelligent control systems.

## Benefits at a glance

- + High efficiency by using solar energy
- + Extremely reliable (no moving parts, low maintenance)
- + No noise emissions
- + Low CO<sub>2</sub> impact, climate-friendly
- + Opportunity to use solar heat in the residential unit (housing construction)
- + Installation couldn't be simpler

A PV system's average internal consumption stands at 30%. AC ELWA-E makes it possible to increase it to 75% (in an average household (5 kWp PV system)).



## Products and applications

### ELWA On-grid for heating water directly



- Not connected to the grid
- For systems without battery storage
- Direct connection of ELWA to PV system (DC); 230V plug can be inserted as a backup
- No inverter, no distribution to the grid, no connection permits required
- Continuously adjustable heat output (0–2 kW)
- Suitable for PV generators with an output of up to 2.5 kWp
- Temperature adjusted using controller on ELWA

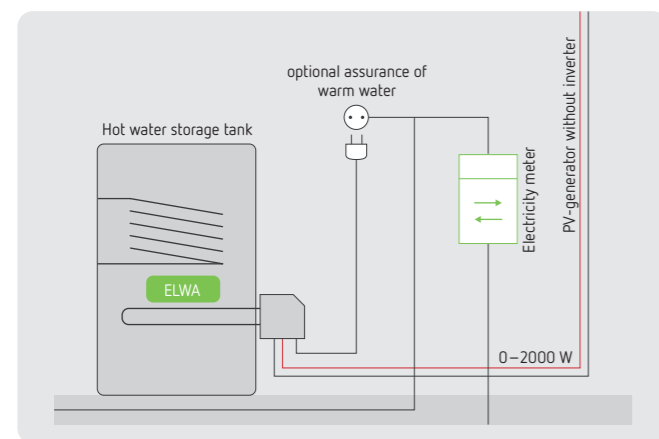

Without grid connection—without battery storage

### How it works

ELWA is a heating element for generating hot water with photovoltaics. Direct current from photovoltaic modules is transferred straight to the built-in heating element and immediately converted into heat without any losses. A connection to the electricity grid is not required for this (pure off-grid operation). No distribution to the grid, no inverter, no connection permits, installation couldn't be simpler. The system provides up to 50% of the hot water required by a household with two to four people. ELWA replaces solar thermal systems of 4–10 m<sup>2</sup> at a photovoltaic output of up to 2.5 kWp. To safeguard the hot water supply, ELWA can automatically reheat from the grid.

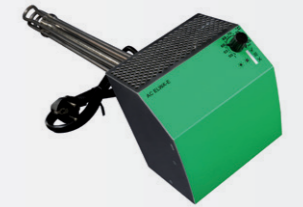

### AC ELWA-E On-grid, use of PV excess for hot water

- For systems with or without battery storage
- ELWA is connected to a power outlet
- Inverter required
- Continuously adjustable heat output (0–3 kW)
- Temperature adjusted using rotary knob on ELWA

### With battery storage

- Communication with AC ELWA-E via battery inverter

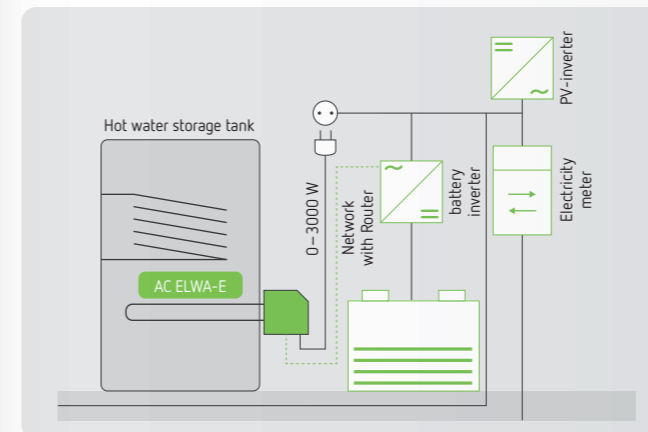

With grid connection— with battery storage

### How it works

AC ELWA-E ensures optimum use of photovoltaic energy. Charging the battery storage is prioritised. As soon as the battery is full, the AC ELWA-E stores the excess energy in hot water. No excess is distributed to the grid. Water is the cheapest form of storage and perfectly complemented by chemical storage batteries.

### Without battery storage

- Reflex power meter required
- The power meter decides on distribution to the grid or own use and communicates with the AC ELWA-E heating element

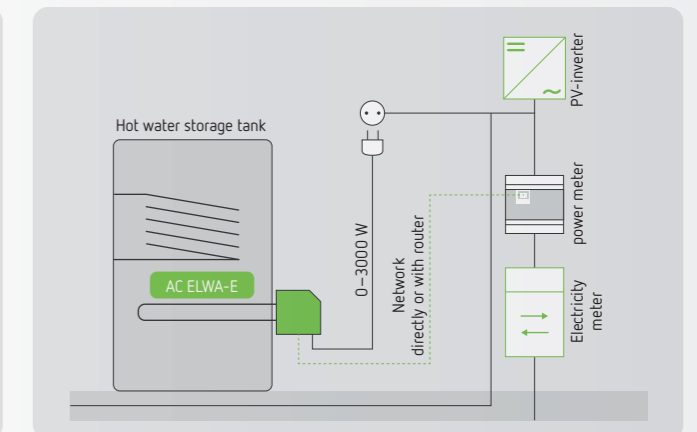

With grid connection— without battery storage  
With power meter

### How it works

In combination with the power meter, the AC ELWA-E only uses excess energy from the photovoltaic system. Continuously adjustable heat output, meaning virtually no energy is distributed to the grid and own consumption increases significantly.

The connection is made via a patch cable to the router, directly with a crossover network cable or wirelessly with commercially available powerline adapters.

The share of own consumption achieved by a PV system is 30% on average. AC ELWA-E makes it possible to increase the share to 75% (in an average household (5 kWp PV system)).

# New at Reflex: Power to Heat

Select heating element and hot water storage tank and estimate heat-up times for hot water storage tanks

## 1. Select PV heating elements

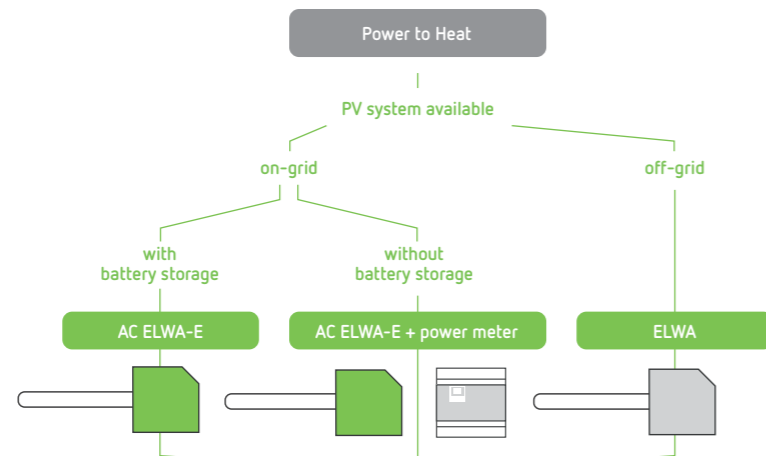

## 2. Select hot water storage tank for PV heating elements

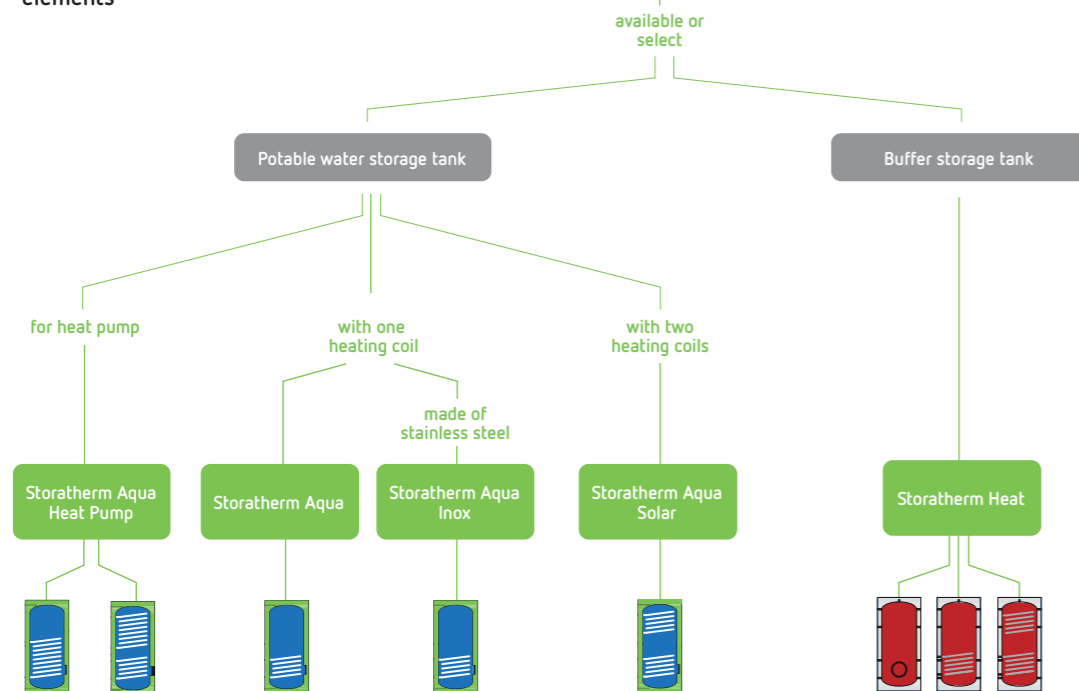

The electric heating elements can be used in all Storatherm Aqua tanks up to 500 l with 1 1/2" sleeve or flange opening (DN 110 + DN 150) and in all Storatherm Heat buffer storage tanks up to 1,000 l.

## Technical data

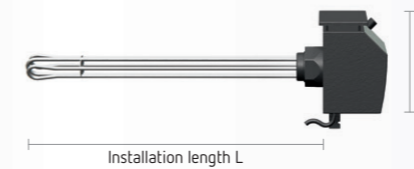

AC ELWA

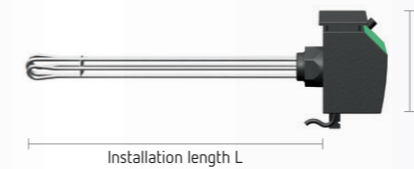

AC ELWA-E

### Technical features

- For off-grid systems, off-grid
- Direct connection of ELWA to PV system (DC); 230V plug can be inserted as a backup
- No inverter, no distribution to the grid, no connection permits required
- Continuously adjustable heat output (0–2 kW)
- Suitable for PV generators with an output of up to 2.5 kWp
- Temperature adjusted using rotary knob on ELWA

### Technical features

- For systems with or without battery storage
- ELWA is connected to a power outlet
- Inverter required
- Continuously adjustable heat output (0–3 kW)
- Temperature adjusted using rotary knob on ELWA

Technical features	Type	Art. no.	Height H [mm]	Width [mm]	Depth T [mm]	Heat output [kW]	Length [L]	Operating temperature [°C]	Protection class	Weight [kg]
	PV heating element, ELWA 2 kW	9127099	180	130	600	2,00	450	10–40	IP 20	2,0
	PV heating element, AC ELWA-E 3 kW	9127101	180	130	600	3,00	450	10–40	IP 21	2,0

## + Accessories

### Reflex 3-phase power meter

- Analysis of the current flows in the PV system
- Transmission of excess output to AC ELWA-E (excess management)
- Connection using a router/switch directly and via powerline possible
- Assembled directly downstream of the utility meter in the distribution cabinet; measures the power flow via three external clamp-on current transducers (assembled without disconnecting phases).

### Reflex USB Interface

- USB interface for ELWA data retrieval software (e.g. yield in kWh, temperature behaviour during operating days)

Typ	Prod. no.
Reflex USB Interface	9127103
Reflex 3-phase power meter (to record the energy distributed back to the grid for the AC ELWA-E)	9127104



# Product overview

## Reflex Storatherm tanks

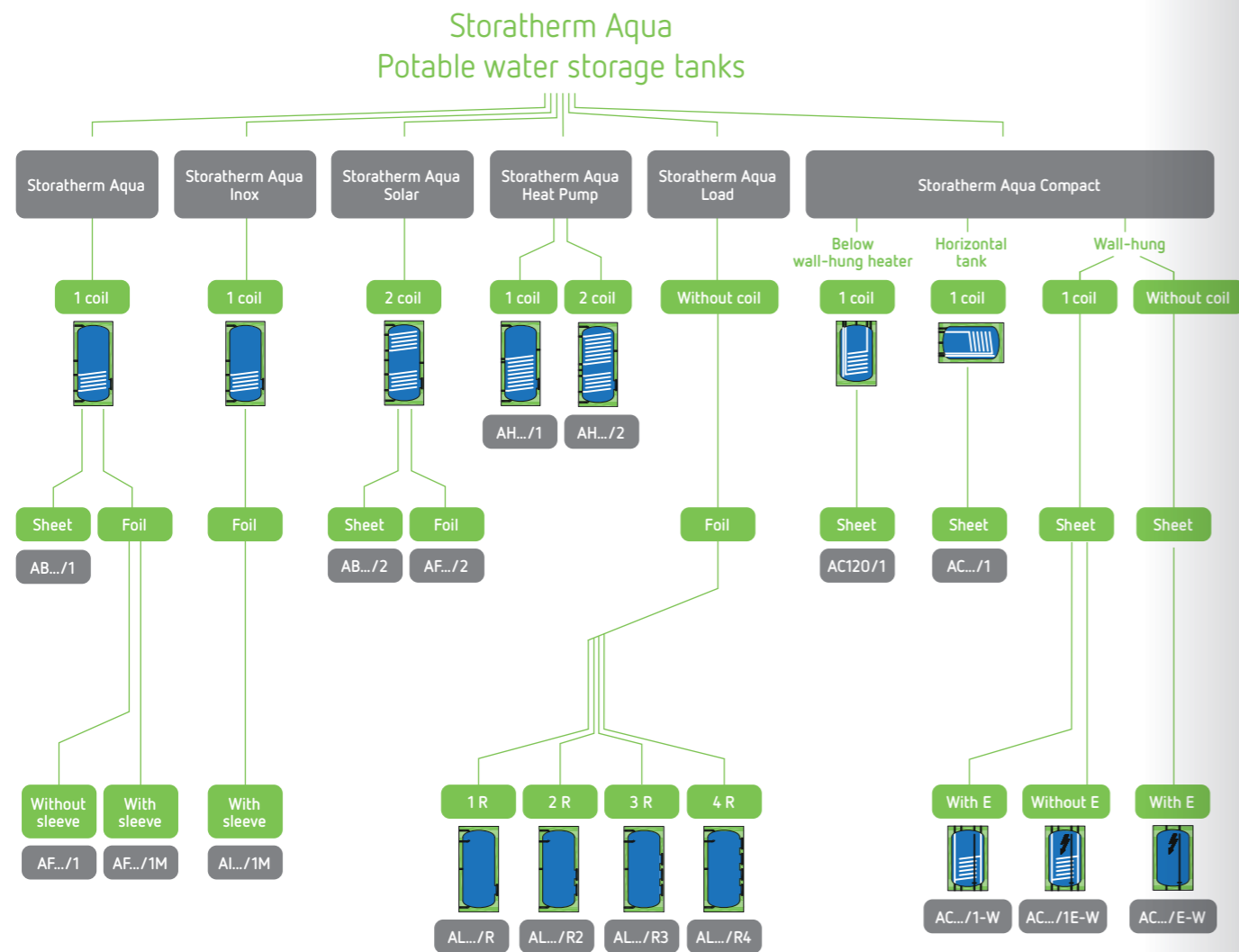

 The type designation comprises the following

- /1 Number heating coils
- /2 Number heating coils
- /R One inspection flange
- /R2 Two inspection flanges
- M With sleeve
- E Electric heater
- W Wall-hung
- \_A; \_B; \_C Energy efficiency class A, B or C

## Storatherm Heat Buffer storage tanks

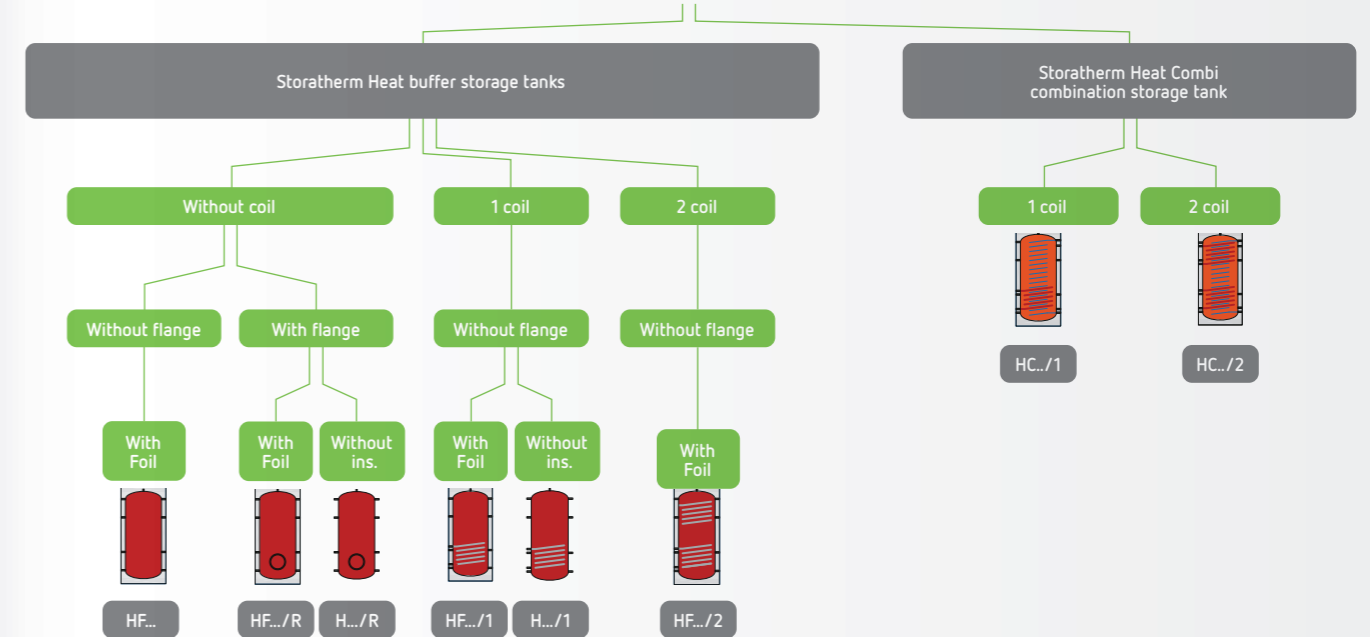

List of abbreviations	
Coil	Heating coil
R	Inspection flange
E	Electric heater

# Potable water storage tanks

## Key benefits

High-grade workmanship for maximum potable water quality and long service life

- Hygienically safe potable water
- Tank surface reliably protected against deposits and corrosion — either by using smooth glass-based surface enamelling or high-grade stainless steel
- Magnesium anode as standard for additional cathodic protection against corrosion

High-performance for comfort at home

- Fast and even heating thanks to generously dimensioned heating surfaces

Energy efficiency from A to C

- Energy efficiency classes A to C thanks to the rECOflex® insulation system; proven in TÜV-certified test facility

Extensive portfolio and accessories

- Wide-ranging standard portfolio and customised designs
- Optional screw-in heating element that uses solar power to heat the water in the hot water storage tank, thus optimising energy consumption

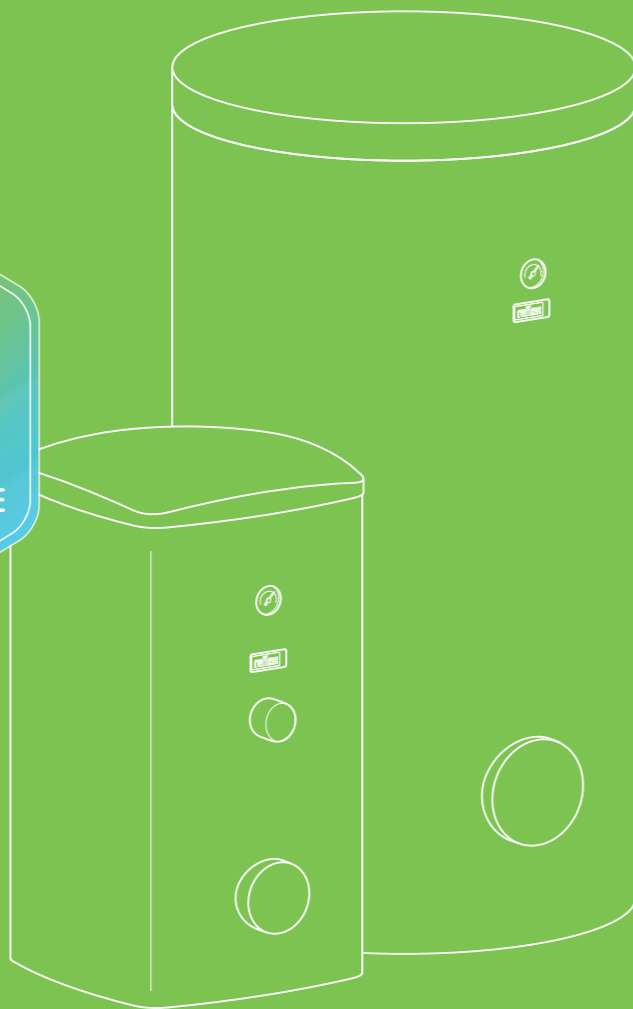

## Design, function, application

### Design: Storatherm Aqua

#### Protective anode

- Optimum protection of your tank against corrosion
- Maintenance-free impressed-current anodes also available as an accessory

#### Circulation connection

- For separate integration of a circulation line

#### Heating surface

- For heating potable water quickly
- Special design permits optimum use of the tank volume

#### Immersion sleeve

- For holding a temperature sensor and measuring the water temperature in the tank

#### Flow baffle

- Prevents turbulence caused by inflowing fresh water
- Essential for optimised tank charging and stable stratification

#### Enamelling

- For hygienically safe and perfectly tasting potable water
- No chance of rust
- The smooth surface reduces limescale and other deposits and scaling to a minimum

#### Heat insulation



- High-grade CFC-free rECOflex® rigid foam
- Sheet metal and foil jackets are available
- Removable white foil jacket available from 750 litres

#### Maintenance opening

- From 150 litres
- Simplifies cleaning and maintenance tasks
- Enables the installation of an additional auxiliary heater or a finned heat exchanger

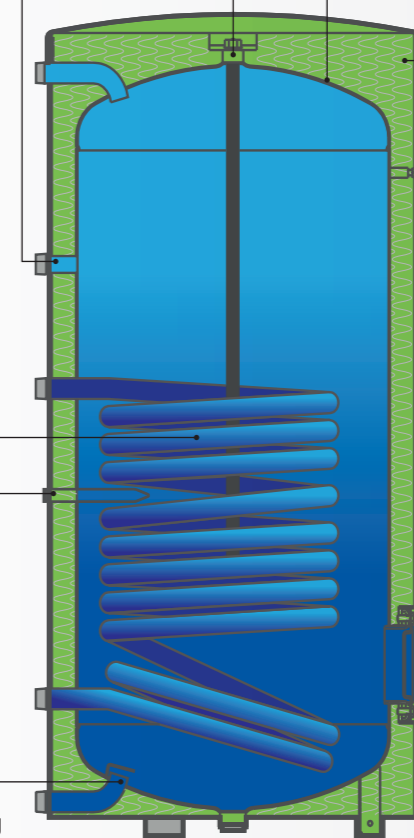

## How it works

### Monovalent heating

The potable water in the tank is heated via a heating medium, usually via an internal heat exchanger which is perfectly dimensioned for operation with low-temperature, heat pump or solar heating systems. The below sketch shows the functioning of the Storatherm Aqua.

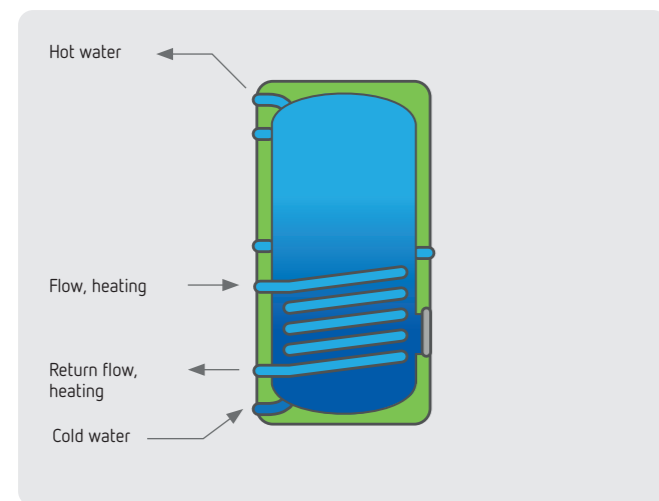

### Bivalent heating

Two internal heat exchangers enable the simultaneous heating of potable water via a conventional boiler and solar system, for example. To prioritise the renewable heating source's full potential, the system is integrated via the lower heating coil. The below sketch shows the functioning of the Storatherm Aqua Solar.

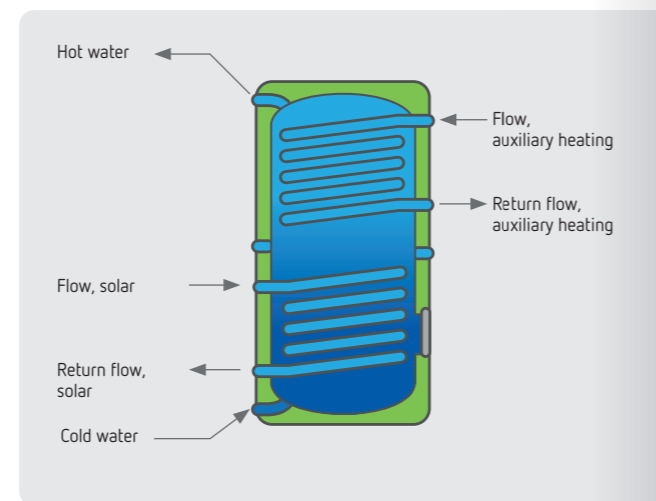

### Functioning of the magnesium anode

An enamel layer protects potable water storage tanks against corrosion. The production of a completely flawless enamel surface is not possible — so-called sacrificial anodes (magnesium anodes) are used to protect defects.

The enamelled tank requiring protection is earthed to the sacrificial anode and a protective current flows immediately after the tank is filled with water. This causes the base metal — in this case the magnesium anode — to dissolve. The dimensioning of the magnesium anode is carried out in accordance with DIN 4753-6.

DIN 4753 has set the magnesium anode's service interval at two years. An anode must be replaced when 2/3 of it is consumed. The service interval can be extended if consumption is lower.

Special, so-called chain anodes must be used during maintenance in basements with a low ceiling.

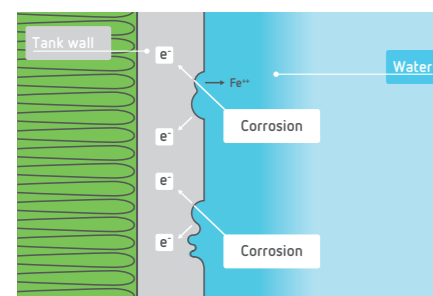

Unprotected tank

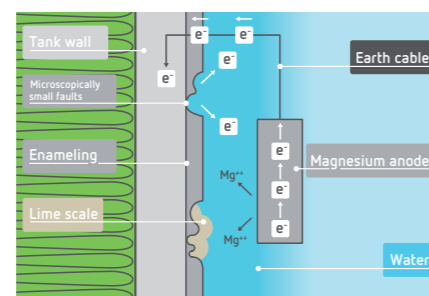

Protection by enamelling and magnesium anode

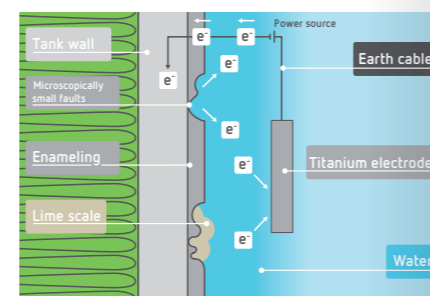

Protection by enamelling and impressed-current anode

## Possible applications

### Storatherm Aqua

- For all heating systems
- With one heating coil



### Storatherm Aqua Solar

- Additional heating coils to make use of solar energy

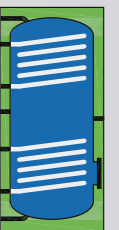

### Storatherm Aqua Heat Pump

- Especially for use in heat pump systems
- High-efficiency tank
- Upsized heating surface
- Available with one or two heating coil(s)



### Storatherm Aqua Load

- For hot water preparation in the tank primary store system
- Available with up to four maintenance openings



### Storatherm Aqua Compact

- In compact series for all heating systems
- Available in wall-hung, horizontal or top-locked versions



### Storatherm Aqua Inox

- For all heating systems
- Made using high-grade stainless steel (1.4521)

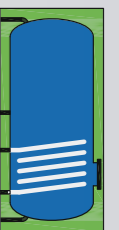

# Potable water storage tanks

rECOflex®

## Storatherm Aqua potable water storage tank with one heating coil

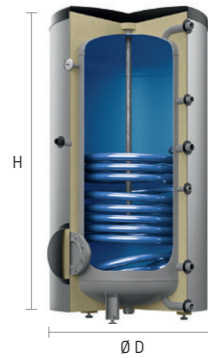

Technical features

- For all heating systems with one heating coil
- Enamelling in accordance with DIN 4753-3, with magnesium anode, thermometer, adjustable feet and maintenance opening
- Up to 500 litres with additional Rp 1½" sleeve for electric heater
- Up to 2,000 litres insulated delivery
- Maximum operating overpressure: heating water 16 bar, potable water 10 bar
- Maximum operating temperature: heating water 110 °C, potable water 95 °C

AB/AF 100/1–3000/1

### Type overview

**AF ... /1M (≤ 500 litres)**  
Potable water storage tank with one heating coil and additional sleeve for electric heater

**Insulation**  
rECOflex® insulation system with foil jacket, non-removable

**AF ... /1 (> 500 litres)**  
Potable water storage tank with one heating coil

**Insulation**  
Up to 1,000 l: 100 mm fleece insulation with foil jacket, removable  
From 1,500 l: 120 mm fleece insulation with foil jacket, removable

**AB ... /1 (≤ 500 litres)**  
Potable water storage tank with one heating coil

**Insulation**  
rECOflex® insulation system with sheet steel cladding, non-removable

Type	Prod. no.		Content [l]	Ø D without/with ins. [mm]	Height H without/with ins. [mm]	Tilted dimension [mm]	Output				Standing losses W	EEC
	white	silver					N <sub>t</sub> <sup>1)</sup>	kW	l/h	V40		
Storatherm Aqua AF ... /1M rECOflex® insulation system with foil jacket												
AF 150/1M_B	7861600	7861100	156	540	1,219	1,270	3	24	606	–	56	B
AF 200/1M_B	7861700	7861200	197	600	1,475	1,525	4.8	30	739	–	52	B
AF 200/1M_C	7847600	7847100	197	540	1,475	1,525	4.8	30	739	–	71	C
AF 300/1M_B	7861800	7861300	303	700	1,334	1,441	11.1	46	1,123	–	70	B
AF 400/1M_B	7861900	7861400	384	750	1,631	1,719	14	56	1,383	–	68	B
AF 400/1M_C	7847800	7847300	384	700	1,631	1,719	14	56	1,383	–	86	C
AF 500/1M_B	7862000	7861500	476	750	1,961	2,029	18.0	56	1,390	–	78	B
AF 500/1M_C	7847900	7847400	476	700	1,961	2,029	18.0	56	1,390	–	100	C
Storatherm Aqua AF ... /1 fleece insulation with foil jacket												
AF 750/1_C	7848000	7838000	750	750/950	1,932/2,023	2,104	30.5	99	2,440	–	–	C
AF 1000/1_C	7848100	7838100	976	850/1,050	1,959/2,050	2,158	38.8	110	2,715	–	–	C
AF 1500/1_C	7848200	–	1,500	1,000/1,240	2,109/2,216	2,371	48	156	3,864	–	–	C
AF 2000/1_C	7848300	–	2,000	1,200/1,440	2,019/2,126	2,226	57	196	4,827	–	–	C
AF 3000/1	7848400	–	2,800	1,200/1,440	2,784/2,878	3,040	66	254	6,260	–	–	–
Storatherm Aqua AB ... /1 rECOflex® insulation system with sheet steel cladding												
AB 100/1_C	7895500	7846400	100	512	849	960	1.3	19	480	–	–	C
AB 150/1_B	7895600	7846500	156	540	1,219	1,270	3	24	606	240	56	B
AB 200/1_C	7895700	7846600	197	540	1,475	1,525	4.8	30	739	314	68	C
AB 300/1_B	7895800	7846700	303	700	1,334	1,441	11.1	46	1,123	415	69	B
AB 400/1_C	7895900	7846800	384	700	1,657	1,719	14	56	1,383	572	84	C
AB 500/1_C	7896100	7846900	476	700	1,961	2,029	18	56	1,390	739	99	C

Information on output subject to heating water supply temperature and heating water flow rate. Continuous output at: heating water flow rate = 3 m³, t<sub>flow</sub> = 80 °C, t<sub>cool</sub> = 10 °C, t<sub>ww</sub> = 45 °C

<sup>1)</sup> Performance index N<sub>t</sub> in accordance with DIN 4708 for storage heating t<sub>s</sub> to 60 °C:  
 t<sub>s</sub> = 60 °C → 1.00 x N<sub>t</sub>    t<sub>s</sub> = 50 °C → 0.55 x N<sub>t</sub>  
 t<sub>s</sub> = 55 °C → 0.75 x N<sub>t</sub>    t<sub>s</sub> = 45 °C → 0.30 x N<sub>t</sub>

### Geometric data: Storatherm Aqua

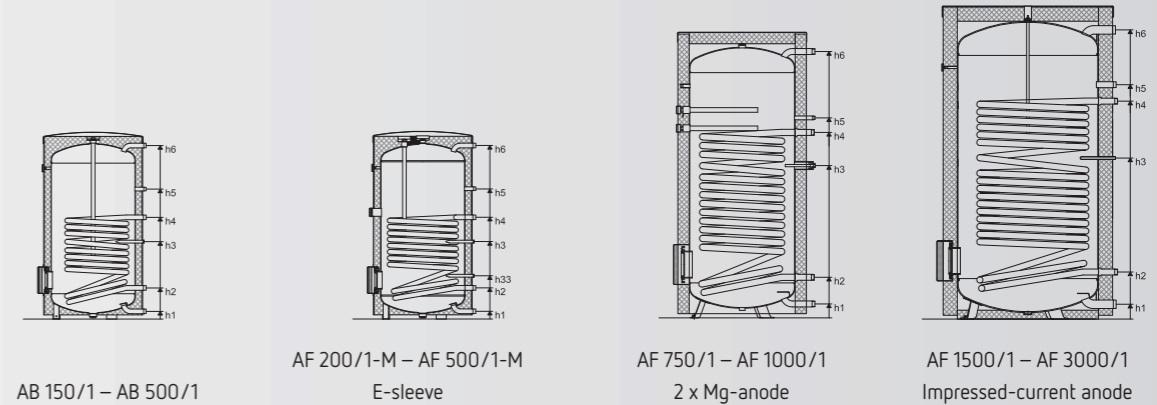

Type		AB 100/1	AF 150/1 AB 150/1	AB 200/1 AF 200/1M	AB 300/1 AF 300/1M	AB 400/1 AF 400/1M	AB 500/1 AF 500/1M	AF 750/1	AF 1000/1	AF 1500/1	AF 2000/1	AF 3000/1	
Weight	/1M_B	kg	38	43	56	78	99	128	259	322	480	650	790
	/1M_C		38	47	56	–	102	117	–	–	–	–	–
	AB		38	47	67	102	123	144	–	–	–	–	–
Hot water, WW	R		¾	¾	¾	1	1	1	1¼	1¼	2	2	2
	h6	mm	740	1,113	1,373	1,229	1,526	1,856	1,886	1,900	2,048	1,937	2,691
Cold water, KW	R		¾	¾	¾	1	1	1	1¼	1¼	2	2	2
	h1	mm	55	55	55	55	55	55	99	103	105	118	156
Circulation, Z	R		¾	¾	¾	¾	¾	¾	¾	¾	1¼	1¼	2
	h5	mm	605	735	902	921	1,112	1,265	1,417	1,489	1,660	1,670	2,406
Heating flow, HV	R		1	1	1	1	1	1	1¼	1¼	1¼	1¼	1¼
	h4	mm	523	599	689	721	909	966	1,314	1,324	1,543	1,568	1,930
Heating return flow, HR	R		1	1	1	1	1	1	1¼	1¼	1¼	1¼	1¼
	h2	mm	193	194	194	221	221	221	288	296	333	360	396
Sensor tube	Ø i x mm		16x200	16x200	16x200	16x200	16x200	16x200	16x200	16x200	16x250	16x250	16x250
	h3	mm	428	464	509	549	684	696	1,079	1,087	1,140	1,175	1,470
	h33	mm	–	283	282	307	369	389	–	–	–	–	–
Blind flange	DN		Rp 1½	110	110	110	110	110	180	80	180	180	180
	LK		–	150	150	150	150	150	225	225	225	225	225
Anode			1 x Mg	1 x Mg	1 x Mg	1 x Mg	1 x Mg	1 x Mg	2 x Mg	2 x Mg	FSA	FSA	FSA
Heating surface	m²		0.61	0.75	0.95	1.40	1.8	1.9	3.7	4.5	6.0	7	9.5
Content, heat exchanger	l		4.1	4.9	6.2	10.1	12.6	13.3	33.7	40.6	55.2	64.5	86.7
Insulation thickness	/1M_B	mm	50	50	50	50	75	75	–	–	–	–	–
	/1		50	50	50	50	50	50	100	100	120	120	120
Max. installation length, EFHR	mm		–	320	320	495	510	510	610	740	740	740	740
Max. installation length, EEHR	/1M	mm	–	–	–	–	–	–	–	–	–	–	–
	/1				460	550	610	610					

Customer drawings for all products available at <http://reflex.cadprofi.com>.

Subject to technical modifications | FSA = impressed-current anode, Mg = magnesium anode, EEHR = electro screw-in heater, EFHR = electro flange heater



# Storatherm Aqua A potable water storage tank with one heating coil

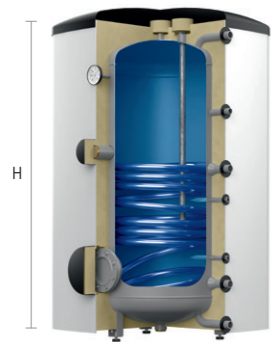

Technical features

- For all heating systems with one heating coil
- Enamelling in accordance with DIN 4753-3, with magnesium anode, thermometer, adjustable feet and maintenance opening
- Additional Rp 1½" sleeve
- Maximum operating overpressure: heating water 16 bar, potable water 10 bar
- Maximum operating temperature: heating water 110 °C, potable water 95 °C

AB/AF 100/1-3000/1

## Type overview



AF ... /1M\_A (≤ 500 litres)  
Potable water storage tank with one heating coil and additional sleeve for electric heater

Insulation  
rECOflex® insulation system with foil jacket, non-removable

Type	Prod. no.		Content [l]	Dimensions [mm]	Height H with ins. [mm]	Tilted dimension [mm]	Output			Standing losses W	EEC	
	white	silver					$N_L^{1)}$	kW	l/h			V40
Storatherm Aqua AF ... /1M_A rECOflex® insulation system with foil jacket												
AF 150/1M_A	7355100	7350100	159	650x650	1,137	1,212	2.4	25	615		36	A
AF 200/1M_A	7355200	7350200	197	650x650	1,329	1,384	4.2	31	760		39	A
AF 300/1M_A	7355300	7350300	302	750x750	1,374	1,451	8.4	48	1,170		49	A
AF 400/1M_A	7355400	7350400	382	790x790	1,671	1,729	15.2	57	1,395		51	A
AF 500/1M_A	7355500	7350500	473	790x790	2,001	2,037	19.1	65	1,590		58	A

## Geometric data: Storatherm Aqua A

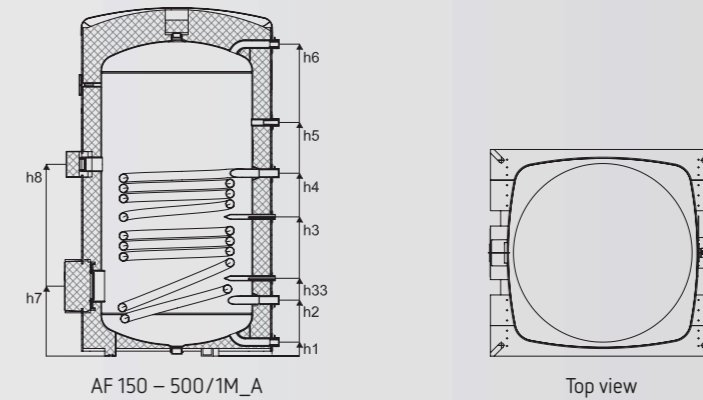

Type		AF 150/1M_A	AF 200/1M_A	AF 300/1M_A	AF 400/1M_A	AF 500/1M_A
Technical data						
Weight	kg	52	60	86	108	126
Hot water, WW	R	1	1	1	1	1
	h6 mm	994	1,194	1,229	1,526	1,856
Cold water, KW	R	1	1	1	1	1
	h1 mm	90	90	55	55	55
Circulation, Z	R	¾	¾	¾	¾	¾
	h5 mm	737	868	921	1,112	1,265
Heating flow, HV	R	1	1	1	1	1
	h4 mm	637	737	721	909	966
Heating return flow, HR	R	1	1	1	1	1
	h2 mm	255	255	221	221	221
Sensor tube	Ø i x mm	16x200	16x200	16x200	16x200	16x200
	h3 mm	511	585	549	684	696
	h33 mm	339	339	307	369	389
Blind flange	DN	110	110	110	110	110
	LK	150	150	150	150	150
Anode		1 x Mg	1 x Mg	1 x Mg	1 x Mg	1 x Mg
Heating surface	m²	0.83	0.95	1.28	1.75	1.88
Content, heat exchanger	l	6	6.6	8.6	12.2	12.8
Insulation thickness	mm	50	75	50	75	75
Max. installation length, EFHR	mm	365	365	462	462	462
Max. installation length, EEHR	mm	500	500	597	597	597

Subject to technical modifications | FSA = impressed-current anode, Mg = magnesium anode, EEHR = electro screw-in heater, EFHR = electro flange heater

Information on output subject to heating water supply temperature and heating water flow rate. Continuous output at:  
heating water flow rate = 3 m³,  $t_{flow} = 80^\circ\text{C}$ ,  $t_{cold} = 10^\circ\text{C}$ ,  $t_{ww} = 45^\circ\text{C}$

<sup>1)</sup> Performance index  $N_L$  in accordance with DIN 4708 for storage heating  $t_s$  to  $60^\circ\text{C}$ :  
 $t_s = 60^\circ\text{C} \rightarrow 1.00 \times N_L$      $t_s = 50^\circ\text{C} \rightarrow 0.55 \times N_L$   
 $t_s = 55^\circ\text{C} \rightarrow 0.75 \times N_L$      $t_s = 45^\circ\text{C} \rightarrow 0.30 \times N_L$

Pressure losses

Storatherm Aqua  
AF/AB 100/1 – AF/AB 500/1

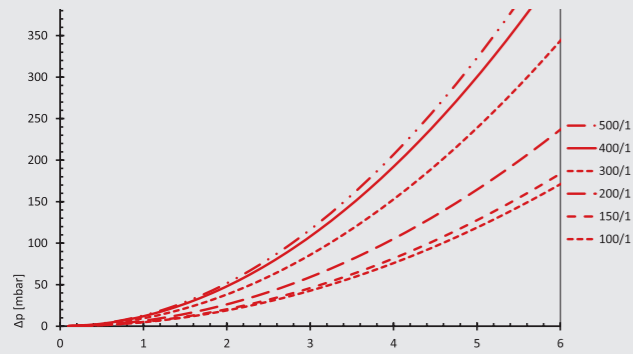

Storatherm Aqua  
AF 750/1 – AF 3000/1

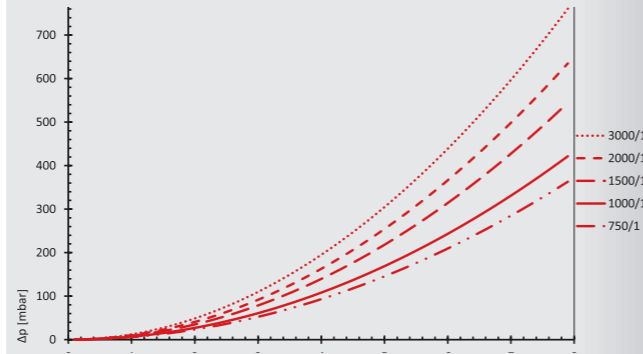

Performance charts

Storatherm Aqua 500/1  
Temperature at tapping point: 60 °C

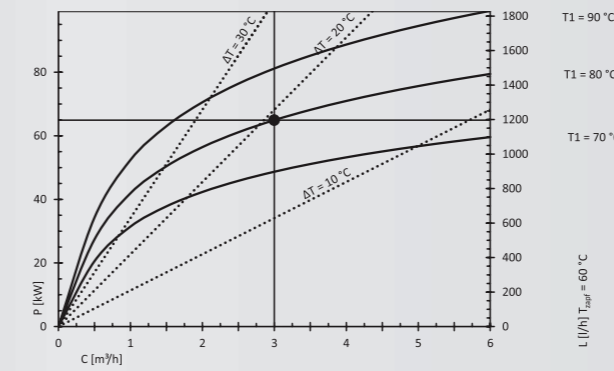

Storatherm Aqua 750/1  
Temperature at tapping point: 45 °C

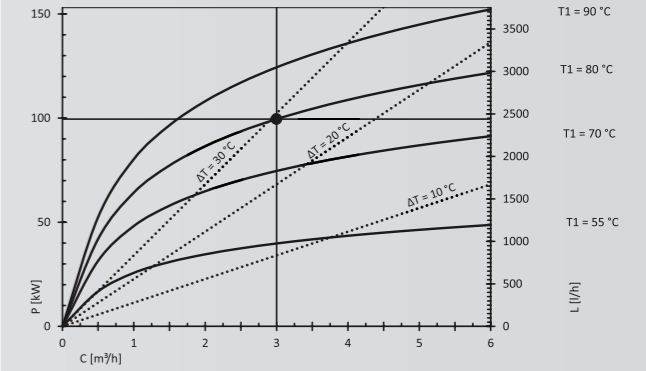

Performance charts

Storatherm Aqua 150/1  
Temperature at tapping point: 60 °C

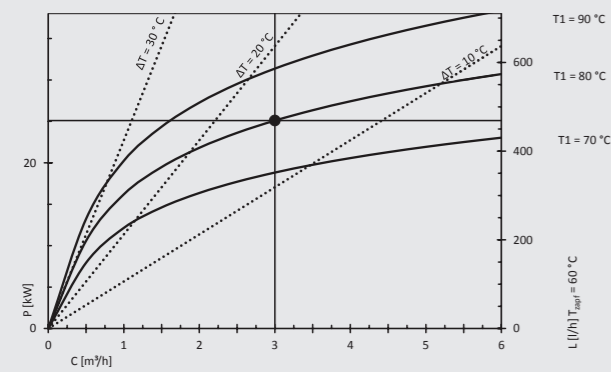

Storatherm Aqua 200/1  
Temperature at tapping point: 60 °C

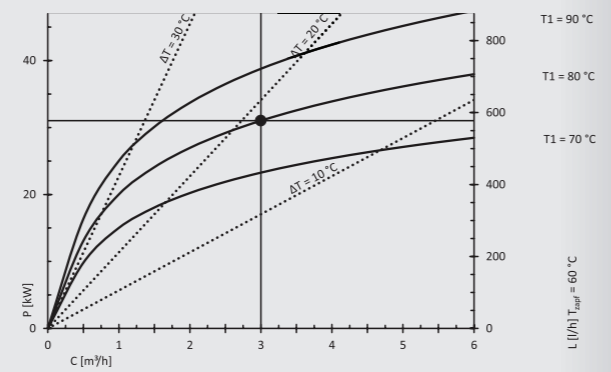

Storatherm Aqua 1000/1  
Temperature at tapping point: 45 °C

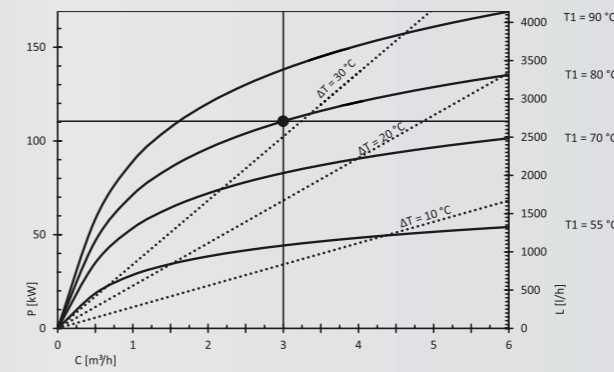

Storatherm Aqua 1500/1  
Temperature at tapping point: 60 °C

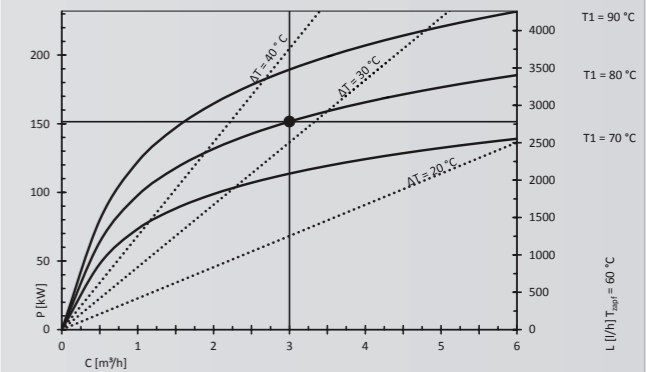

Storatherm Aqua 300/1  
Temperature at tapping point: 60 °C

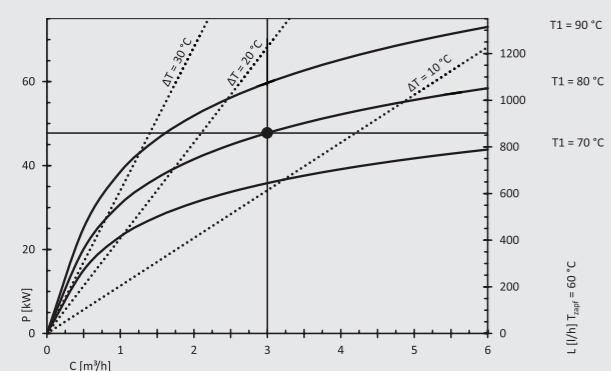

Storatherm Aqua 400/1  
Temperature at tapping point: 60 °C

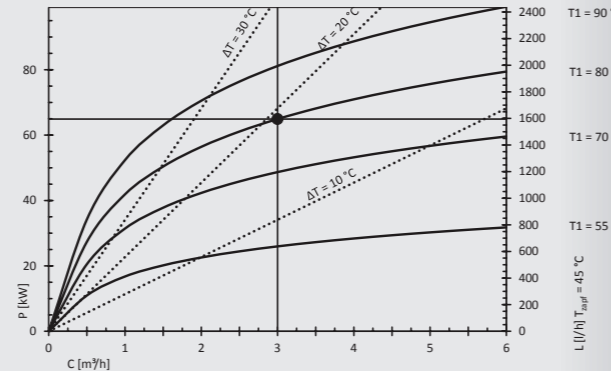

Storatherm Aqua 2000/1  
Temperature at tapping point: 60 °C

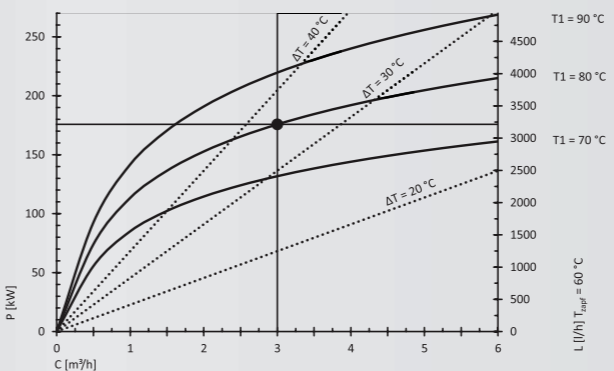

Storatherm Aqua 3000/1  
Temperature at tapping point: 60 °C

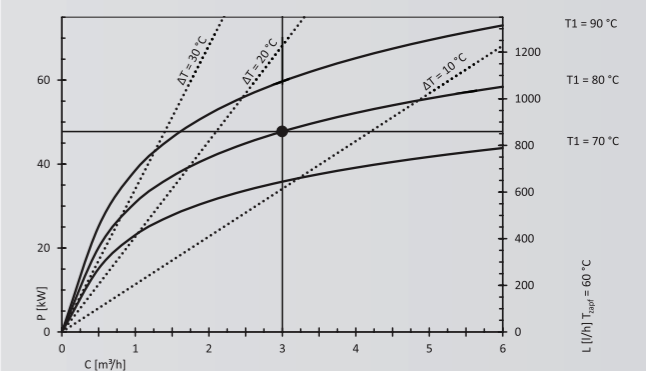



# Storatherm Aqua Solar potable water storage tank with two heating coils

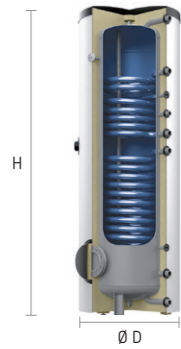

Technical features

- Additional heating coil to make use of solar energy
- Enamelling in accordance with DIN 4753-3, with magnesium anode, thermometer, adjustable feet and maintenance opening
- Up to 2,000 litres insulated delivery
- Maximum operating overpressure: heating water 16 bar, potable water 10 bar
- Maximum operating temperature: heating water 110 °C, potable water 95 °C

AB/AF 200/2 – 3000/2

### Type overview

**AF .../2 (≤ 500 litres)**  
Potable water storage tank with two heating coils  
**Insulation**  
rECOflex® insulation system with foil jacket, non-removable

**AF .../2 (> 500 litres)**  
Potable water storage tank with two heating coils  
**Insulation**  
Up to 1,000 l: 100 mm fleece insulation with foil jacket, removable  
From 1,500 l: 120 mm fleece insulation with foil jacket, removable

**AB .../2 (≤ 500 litres)**  
Potable water storage tank with two heating coils  
**Insulation**  
rECOflex® insulation system with sheet steel cladding, non-removable

Type	Prod. no.		Content [l]	Ø D with ins. [mm]	Height H without/with ins. [mm]	Tilted dimension [mm]	Lower heating register output				Upper heating register output				Standing losses W	EEC
	white	silver					N <sub>L</sub> <sup>1)</sup> kW	l/h	V40	N <sub>L</sub> <sup>1)</sup> kW	l/h	V40				
<b>Storatherm Aqua Solar AF/.../2</b>																
AF 200/2_B	7862100	7896700	196	600	1,475	1,524	5.4	28	693	307	1.4	24	586	143	52	B
AF 200/2_C	7848800	7896800	196	540	1,475	1,530									71	C
AF 300/2_B	7849800	-	303	700	1,294	1,438	11.8	45	1,095	455	2.7	27	668	165	70	B
AF 300/2S_B	7862200	7862500	299	650	1,834	1,884	10.9	46	1,145	458	2.1	25	624	181	62	B
AF 300/2S_C	7849000	7836300	299	600	1,834	1,884									83	C
AF 400/2_B	7862300	7862600	382	750	1,657	1,721	16.4	55	1,372	609	2.9	31	755	322	68	B
AF 400/2_C	7849100	7849900	382	700	1,657	1,721									86	C
AF 500/2_B	7862400	7862700	482	750	1,961	2,029	19.7	53	1,304	-	5.4	37	916	-	78	B
AF 500/2_C	7849200	7850000	474	700	1,961	2,029									100	C
<b>Storatherm Aqua Solar AF/.../2</b>																
AF 750/2_C	7849300	7838500	751	750/950	1,932/2,035	2,104	21	60	1,460	-	6.2	33	815	-	129	C
AF 1000/2_C	7849400	7838600	972	850/1,050	1,989/2,060	2,158	26	76	1,870	-	7.1	32	780	-	146	C
AF 1500/2_C	7849500	-	1,500	1,000/1,240	2,109/2,230	2,371	29	99	1,430	-	11.4	57	1,390	-	171	C
AF 2000/2_C	7849600	-	2,000	1,200/1,440	2,019/2,140	2,226	32.3	112	2,449	-	14.4	72	1,760	-	188	C
AF 3000/2*	7849700	-	2,800	1,200/1,440	2,784/2,903	3,400	44.2	166	4,098	-	18.2	91	2,245	-	-	-
<b>Storatherm Aqua Solar AB.../2</b>																
AB 300/2S_C	7896400	7848500	299	600	1,834	1,884	8.4	48	1,170	-	2.2	26	630	-	83	C
AB 400/2_C	7896500	7836400	382	700	1,657	1,721	15.2	57	1,395	-	2.9	31	755	-	86	C
AB 500/2_C	7896600	7848700	474	700	1,961	2,029	19.7	53	1,304	-	5.4	37	916	-	100	C

\* Order insulation separately (product number: 5914600)

Information on output subject to heating water supply temperature and heating water flow rate. Continuous output at: heating water flow rate = 3 m³, t<sub>flow</sub> = 80 °C, t<sub>cool</sub> = 10 °C, t<sub>ww</sub> = 45 °C

<sup>1)</sup> Performance index N<sub>L</sub> in accordance with DIN 4708 for storage heating t<sub>s</sub> to 60 °C:  
t<sub>s</sub> = 60 °C → 1.00 x N<sub>L</sub>    t<sub>s</sub> = 50 °C → 0.55 x N<sub>L</sub>  
t<sub>s</sub> = 55 °C → 0.75 x N<sub>L</sub>    t<sub>s</sub> = 45 °C → 0.30 x N<sub>L</sub>

### Geometric data: Storatherm Aqua Solar



AF 200/2 – AF 500/2  
AB 300/2 – AB 500/2

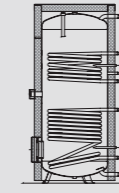

AF 750/2 – AF 1000/2

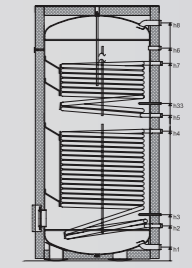

AF 1500/2 – AF 3000/2

Technical data	Type	Type													
		AF 200/2	AF 300/2S AB 300/2S	AF 300/2	AF 400/2 AB 400/2	AF 500/2 AB 500/2	AF 750/2	AF 1000/2	AF 1500/2	AF 2000/2	AF 3000/2				
Weight	AF.../2_B	kg	64	-	90	111	130	-	-	-	-	-	-	-	-
	AF.../2_C		67	-	-	117	134	216	278	495	670	820			
	AF.../2S_B		-	103	-	-	-	-	-	-	-	-	-	-	-
	AF.../2S_C		-	99	-	-	-	-	-	-	-	-	-	-	-
	AB.../2_C		-	-	-	138	155	-	-	-	-	-	-	-	-
Hot water, WW		R	3/4	1	1	1	1 ¼	1 ¼	1 ¼	2	2	2			
	h8	mm	1,373	1,725	1,229	1,526	1,856	1,887	1,905	2,048	1,937	2,691			
Cold water, KW		R	3/4	1	1	1	1 ¼	1 ¼	1 ¼	2	2	2			
	h1	mm	55	90	55	55	55	99	103	105	118	156			
Circulation, Z		R	3/4	3/4	3/4	3/4	3/4	3/4	3/4	1 ¼	1 ¼	1 ¼			
	h6	mm	902	1,178	626	1,112	1,265	1,242	1,243	1,746	1,695	2,406			
Heating flow, HV		R	1	1	1	1	1	1	1	1 ¼	1 ¼	1 ¼			
	h7	mm	1,149	1,423	1,049	1,355	1,605	1,467	1,423	1,692	1,613	2,235			
Heating return flow, HR		R	1	1	1	1	1	1	1	1 ¼	1 ¼	1 ¼			
	h5	mm	789	1,063	791	1,007	1,115	1,151	1,153	1,229	1,224	1,645			
Solar flow, SV		R	1	1	1	1	1	1	1	1 ¼	1 ¼	1 ¼			
	h4	mm	689	964	715	908	965	830	884	1,065	1,080	1,466			
Solar return flow, SR		R	1	1	1	1	1	1	1	1 ¼	1 ¼	1 ¼			
	h2	mm	194	254	221	221	221	288	297	333	360	396			
Sensor tube		Ø i x mm	16x200	16x200	16x200	16x200	16x200	16x200	16x250	16x250	16x250	16x250			
	h3	mm	1,014	1,288	921	1,224	1,412	13.32	1,333	1,350	1,344	1,780			
Blind flange		DN	110	110	110	110	110	180	180	180	180	180			
	LK	mm	150	150	150	150	150	225	225	225	225	225			
Anode			1 x Mg	1 x Mg	1 x Mg	1 x Mg	1 x Mg	1 x Mg	1 x Mg	FSA	FSA	FSA			
Heating surface (top)		m²	0.7	0.8	0.85	1.50	1.3	1.17	1.17	1.9	2.25	3.4			
Content, heat exchanger (top)		l	4.9	6	5.8	7	8.9	8.2	7.9	17.5	21.8	32.2			
Heating surface (bottom)		m²	0.95	1.55	1.45	1.8	1.9	1.93	2.45	3.8	4.2	6.8			
Content, heat exchanger (bottom)		l	6.4	11	10.1	12.6	13.3	13.5	17.1	35	43.6	62.2			
Insulation thickness		mm	50	75	50	50	75	50	75	50	75	50			
Max. installation length, EFHR		mm	460	510	510	510	510	610	740	740	740	740			
Max. installation length, EEHR		mm	320	400	610	610	610	750	850	850	850	850			

Subject to technical modifications | FSA = impressed-current anode, Mg = magnesium anode, EEHR = electro screw-in heater, EFHR = electro flange heater



Storatherm Aqua Solar A potable water storage tank with two heating coils

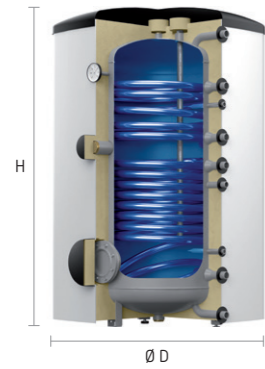

Technical features

- Additional heating coil to make use of solar energy
- Enamelling in accordance with DIN 4753-3, with magnesium anode, thermometer, adjustable feet and maintenance opening
- Maximum operating overpressure: heating water 16 bar, potable water 10 bar
- Maximum operating temperature: heating water 110 °C, potable water 95 °C

AF 200 – 500/2\_A

Type overview



AF .../2\_A (≤ 500 litres)  
Potable water storage tank with two heating coils

Insulation  
rECOflex® insulation system with foil jacket, non-removable

Type	Prod. no.		Content	Dimen- sions [mm]	Height H with ins. [mm]	Tilted dimen- sion [mm]	Lower heating register output				Upper heating register output				Standing losses W	EEC
	white	silver					N <sub>L</sub> <sup>1)</sup>	kW	l/h	V40	N <sub>L</sub> <sup>1)</sup>	kW	l/h	V40		
Storatherm Aqua Solar AF / .../2 rECOflex® insulation system with foil jacket heat insulation																
AF 200/2_A	7355600	7350600	196	650x650	1,329	1,384	4.2	31	760		1.1	24	550		40	A
AF 300/2_A	7355700	7350700	300	750x750	1,374	1,452	8.4	48	1,170		2.2	26	630		48	A
AF 400/2_A	7355800	7350800	380	790x790	1,671	1,729	15.2	57	1,395		3.4	31	740		53	A
AF 500/2_A	7355900	7350900	470	790x790	2,001	2,037	19.1	65	1,590		5.9	40	970		58	A

Geometric data: Storatherm Aqua Solar A

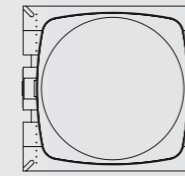

Top view

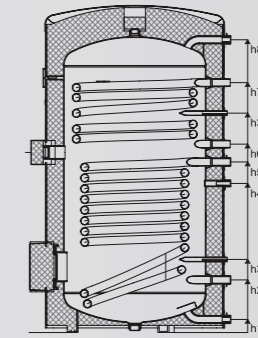

AF 200 – 500/2\_A

Type		AF 200/2_A	AF 300/2_A	AF 400/2_A	AF 500/2_A	
Technical data	Weight	kg	68	97	120	141
	Hot water, WW	R	1	1	1	1
h8		mm	1,194	1,229	1,526	1,856
Cold water, KW	R	1	1	1	1	
	h1	mm	90	55	55	55
Circulation, Z	R	¾	¾	¾	¾	
	h4	mm	547	626	1,112	1,265
Heating flow, HV	R	1	1	1	1	
	h7	mm	998	1,049	1,355	1,604
Heating return flow, HR	R	1	1	1	1	
	h6	mm	737	791	1,007	1,114
Solar flow, SV	R	1	1	1	1	
	h5	mm	637	716	908	966
Solar return flow, SR	R	1	1	1	1	
	h2	mm	255	221	221	221
Sensor tube	Ø i x mm	16x200	16x200	16x200	16x200	
	h3	mm	868	921	1,224	1,410
	h33	mm	339	307	369	389
Blind flange	DN	110	110	110	110	
	LK	150	150	150	150	
Anode		1 x Mg	1 x Mg	1 x Mg	1 x Mg	
Heating surface (top)	m²	0.95	0.84	1.0	1.28	
Content, heat exchanger (top)	l	6.6	5.8	7.0	9.0	
Heating surface (bottom)	m²	0.67	1.42	1.75	1.88	
Content, heat exchanger (bottom)	l	4.2	9.8	12.2	13.0	
Insulation thickness	mm	75	50	75	75	
Max. installation length, EFHR	mm	365	462	462	462	
Max. installation length, EEHR	mm	500	597	597	597	

Customer drawings for all products available at <http://reflex.cadprofi.com>.

Subject to technical modifications | FSA = impressed-current anode, Mg = magnesium anode, EEHR = electro screw-in heater, EFHR = electro flange heater

Information on output subject to heating water supply temperature and heating water flow rate. Continuous output at: heating water flow rate = 3 m³, t<sub>flow</sub> = 80 °C, t<sub>cool</sub> = 10 °C, t<sub>ww</sub> = 45 °C

<sup>1)</sup> Performance index N<sub>L</sub> in accordance with DIN 4708 for storage heating t<sub>s</sub> to 60 °C:  
 t<sub>s</sub> = 60 °C → 1.00 x N<sub>L</sub>    t<sub>s</sub> = 50 °C → 0.55 x N<sub>L</sub>  
 t<sub>s</sub> = 55 °C → 0.75 x N<sub>L</sub>    t<sub>s</sub> = 45 °C → 0.30 x N<sub>L</sub>



Pressure losses

Storatherm Aqua Solar  
200/2, 300/2, 300/2S, 400/2 and 500/2

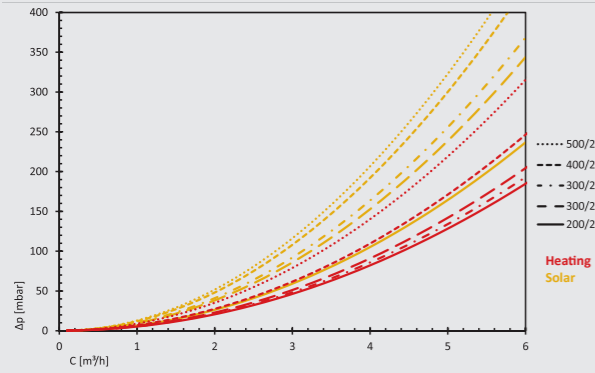

Storatherm Aqua Solar  
750/2, 1000/2, 1500/2S, 2000/2 and 3000/2

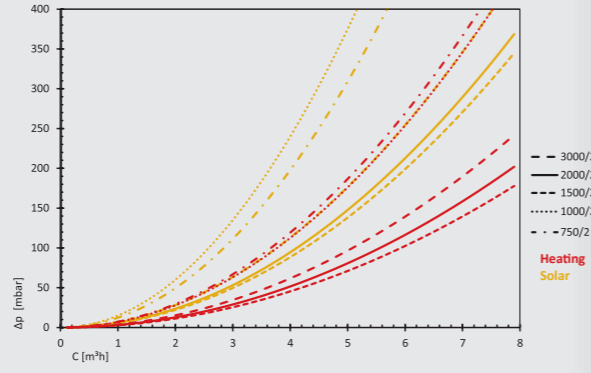

Performance charts

Storatherm Aqua Solar 750/2  
Temperature at tapping point: 45 °C

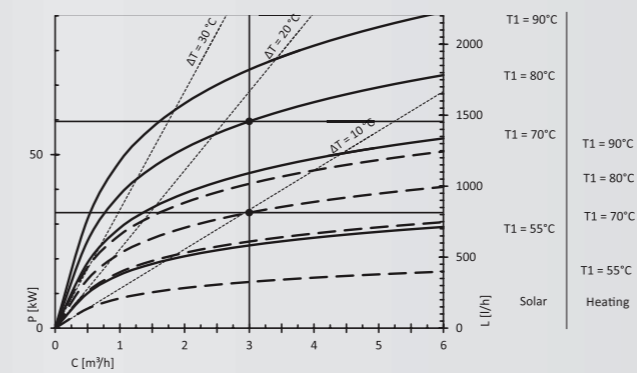

Storatherm Aqua Solar 1000/2  
Temperature at tapping point: 45 °C

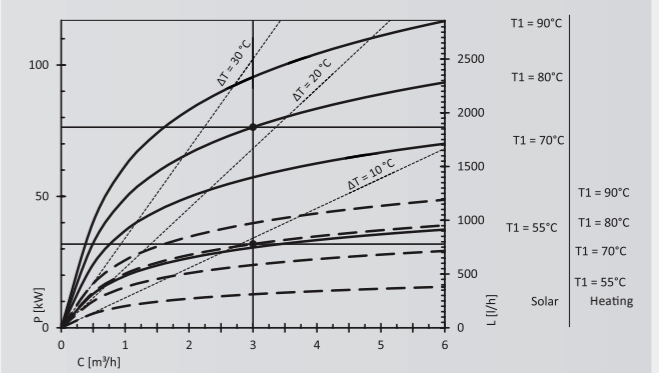

Performance charts

Storatherm Aqua Solar 200/2  
Temperature at tapping point: 45 °C

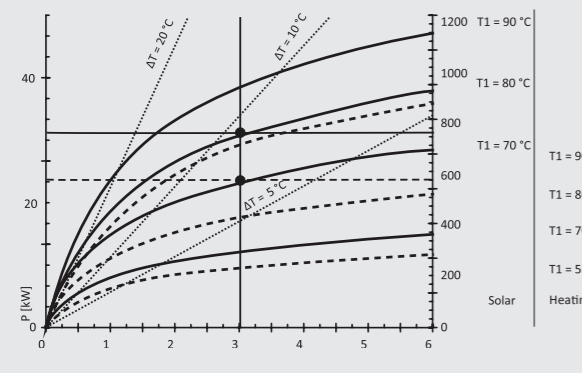

Storatherm Aqua Solar 300/2  
Temperature at tapping point: 45 °C

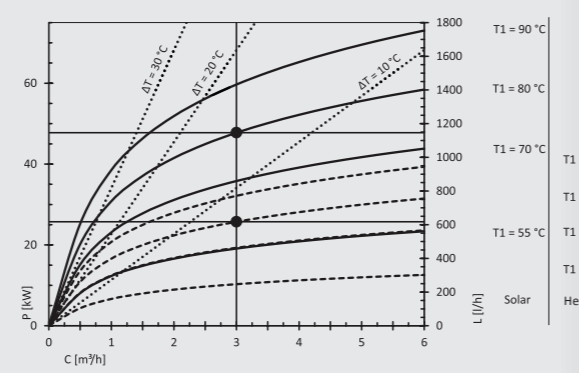

Storatherm Aqua Solar 1500/2  
Temperature at tapping point: 45 °C

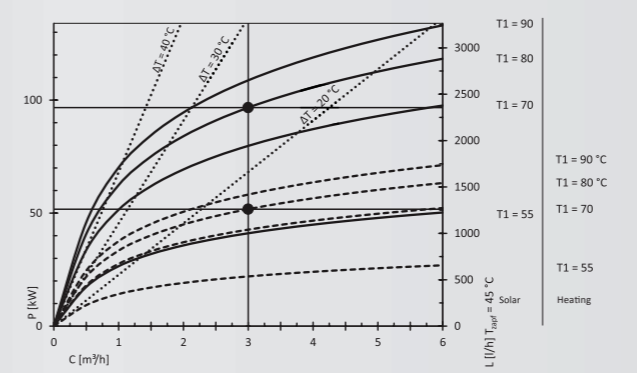

Storatherm Aqua Solar 2000/2  
Temperature at tapping point: 45 °C

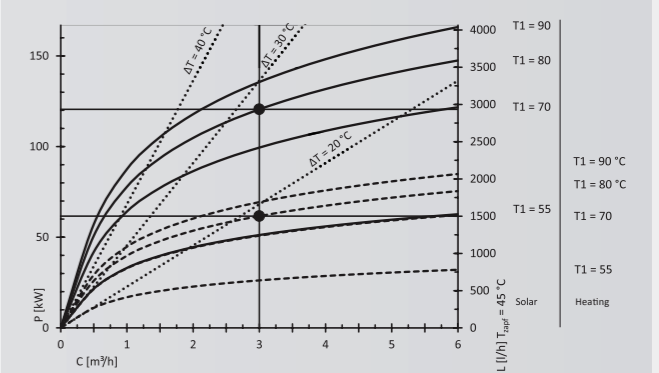

Storatherm Aqua Solar 400/2  
Temperature at tapping point: 45 °C

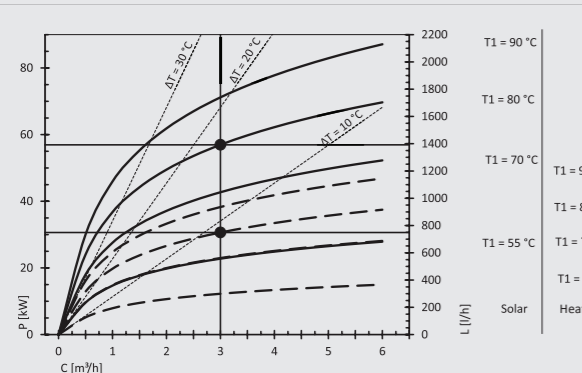

Storatherm Aqua Solar 500/2  
Temperature at tapping point: 45 °C

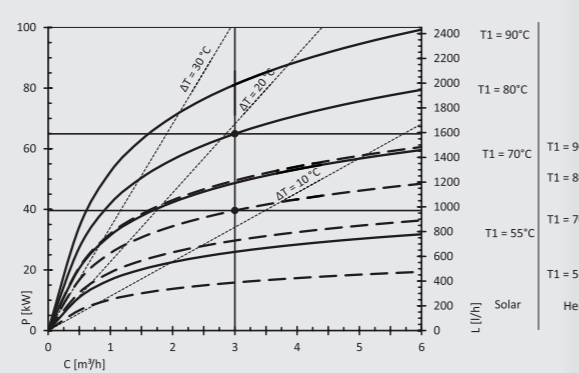

Storatherm Aqua Solar 3000/2  
Temperature at tapping point: 45 °C

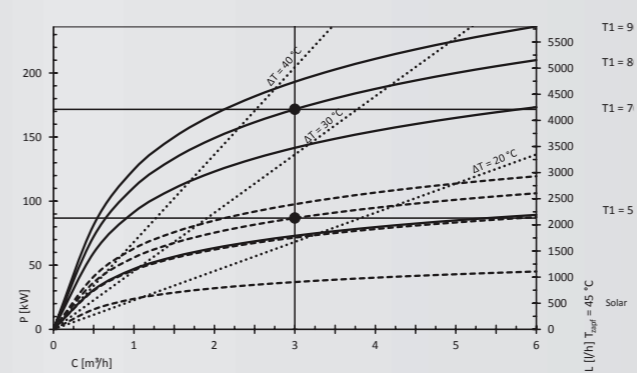



# Storatherm Aqua Heat Pump potable water storage tank for heat pumps

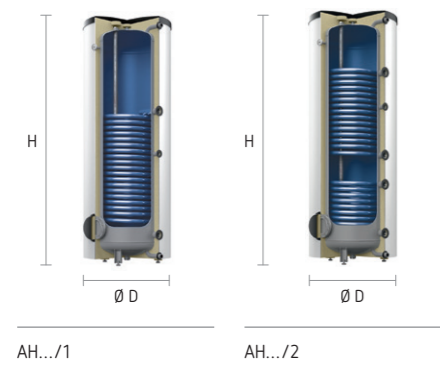

Technical features

- Upsized heating surface, especially for use in heat pump systems
- Enamelling executed in accordance with DIN 4753-3
- Magnesium anode and thermometer, adjustable feet and maintenance opening
- 1 1/2" sleeve
- Up to 2,000 litres insulated delivery
- Maximum operating overpressure: heating water 16 bar, potable water 10 bar
- Maximum operating temperature: heating water 110 °C, potable water 95 °C

### Type overview

**AH .../1**  
Potable water storage tank with one heating coil

**Insulation**  
Up to 500 l: rECOflex® insulation system with foil jacket, non-removable  
From 750 l: 100 mm fleece insulation with foil jacket, removable  
From 1,500 l: 120 mm fleece insulation with foil jacket, removable

**AH .../2**  
Potable water storage tank with two heating coils

**Insulation**  
Up to 500 l: rECOflex® insulation system with foil jacket, non-removable  
From 750 l: 100 mm fleece insulation with foil jacket, removable  
From 1,500 l: 120 mm fleece insulation with foil jacket, removable

Type	Prod. no.	Content [l]	Ø D with ins. [mm]	Height H with ins. [mm]	Tilted dimension [mm]	Output, heating				Output, solar				Standing losses W	EEC
						N <sub>L</sub> <sup>1)</sup>	kW	l/h	V40	N <sub>L</sub> <sup>1)</sup>	kW	l/h	V40		
Storatherm Aqua Heat Pump AH .../1 with one heating coil															
AH 300/1_B	7864000	302	700	1,334	1,441	13.3	82	2,011	500	-	-	-	-	70	B
AH 400/1_B	7864100	380	750	1,631	1,722	15.1	108	2,626	597	-	-	-	-	68	B
AH 400/1_C	7845600	380	700	1,631	1,722									86	C
AH 500/1_B	7864200	469	750	1,961	2,029	22.1	124	3,006	766	-	-	-	-	78	B
AH 500/1_C	7845700	469	700	1,961	2,029									100	C
AH 750/1_C	7845800	729	950	2,050	2,107	40	152	3,712	-	-	-	-	-	141	C
AH 1000/1_C	7845900	965	1,050	2,083	2,158	59	203	4,965	-	-	-	-	-	140	C
Storatherm Aqua Heat Pump AH .../2 with two heating coils															
AH 400/2_B	7864300	374	750	1,591	1,721	9.1	64	1,556	-	15	40	972	-	68	B
AH 400/2_C	7846000	374	700	1,591	1,721									87	C
AH 500/2_B	7864400	469	750	1,961	2,029	11.2	88	2,148	-	25	46	1,116	-	78	B
AH 500/2_C	7846100	469	700	1,961	2,029									100	C
AH 750/2_C	7846200	727	950	2,050	2,107	34	110	2,687	-	17	60	1,465	-	128	C
AH 1000/2_C	7846300	965	1,050	2,083	2,158	43	132	3,226	-	25	82	2,004	-	141	C

### Geometric data: Storatherm Aqua Heat Pump

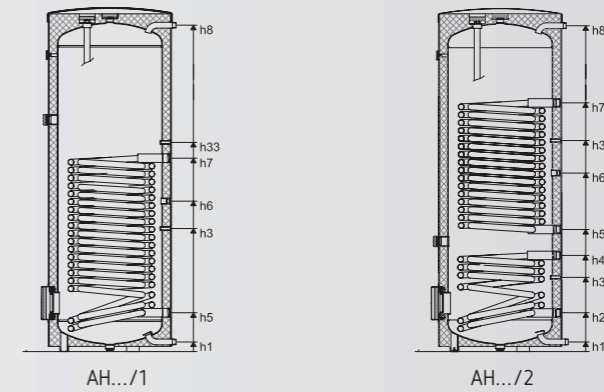

Type		AH 300/1	AH 400/1	AH 500/1	AH 750/1	AH 1000/1	AH 400/2	AH 500/2	AH 750/2	AH 1000/2
Technical data	EEC B	kg	116	160	216	-	-	155	190	-
	EEC C	kg	-	167	201	263	335	181	247	283
Hot water, WW	R		1	1	1	1 1/4	1 1/4	1	1	1 1/4
	h8	mm	1,229	1,526	1,856	1,887	1,905	1,526	1,856	1,887
Cold water, KW	R		1	1	1	1 1/4	1 1/4	1	1	1 1/4
	h1	mm	55	55	55	99	103	55	55	99
Circulation, Z	Rp/R		Rp 3/4	Rp 3/4	Rp 3/4	R 3/4	R 3/4	Rp 3/4	Rp 3/4	R 3/4
	h6	mm	545	666	1,035	990	1,045	860	1,017	1,116
Heating flow, HV	Rp/R		Rp 1 1/4	Rp 1 1/4	Rp 1 1/4	R 1 1/4	R 1 1/4	Rp 1 1/4	Rp 1 1/4	R 1 1/4
	h7	mm	785	1,100	1,279	1,260	1,360	1,146	1,416	1,426
Heating return flow, HR	Rp/R		Rp 1 1/4	Rp 1 1/4	Rp 1 1/4	R 1 1/4	R 1 1/4	Rp 1 1/4	Rp 1 1/4	R 1 1/4
	h5	mm	221	221	220	287	297	606	1,114	769
Solar flow, SV	Rp/R		-	-	-	-	-	Rp 1 1/4	Rp 1 1/4	R 1 1/4
	h4	mm	-	-	-	-	-	471	696	646
Solar return flow, SR	Rp/R		-	-	-	-	-	Rp 1 1/4	Rp 1 1/4	R 1 1/4
	h2	mm	-	-	-	-	-	221	221	287
Sensor tube	Ø	mm	16	16	16	16	16	16	16	16
	h3	mm	875	1,190	1,369	1,060-1,510	1,060-1,510	385	424	1,060-1,510
Blind flange	DN	mm	110	110	110	180	180	110	110	180
	LK	mm	150	150	150	225	225	150	150	225
Anode			1 x Mg	1 x Mg	1 x Mg	1 x Mg	1 x Mg	1 x Mg	1 x Mg	1 x Mg
Heating surface (top)	m²		3.2	5.0	6.2	7.0	9.2	3.2	4.3	5.2
Content, heat exchanger (top)	l		24	35	43	49	64	21.5	30	39.6
Heating surface (bottom)	m²		-	-	-	-	-	1.4	1.6	2.2
Content, heat exchanger (bottom)	l		-	-	-	-	-	9.5	11	15.6
Insulation thickness	mm		50	50	50	100	100	50	50	100
Max. installation length, EFHR	mm		450	450	450	600	700	450	450	600
Max. installation length, EEHR	mm		530	530	530	810	810	530	530	810

Subject to technical modifications | FSA = impressed-current anode, Mg = magnesium anode, EEHR = electro screw-in heater, EFHR = electro flange heater

Information on output subject to heating water supply temperature and heating water flow rate. Continuous output at: heating water flow rate = 3 m³, t<sub>flow</sub> = 80 °C, t<sub>cool</sub> = 10 °C, t<sub>ww</sub> = 45 °C

<sup>1)</sup> Performance index N<sub>L</sub> in accordance with DIN 4708 for storage heating t<sub>s</sub> to 60 °C:  
 t<sub>s</sub> = 60 °C → 1.00 x N<sub>L</sub>    t<sub>s</sub> = 50 °C → 0.55 x N<sub>L</sub>  
 t<sub>s</sub> = 55 °C → 0.75 x N<sub>L</sub>    t<sub>s</sub> = 45 °C → 0.30 x N<sub>L</sub>

Pressure losses

Storatherm Aqua Heat Pump 300/1, 400/1, 500/1, 750/1 and 1000/1

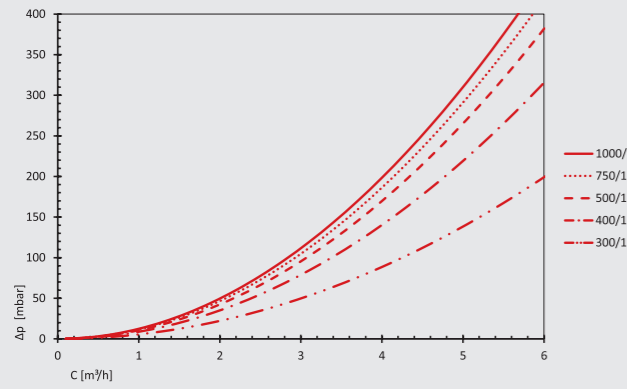

Storatherm Aqua Heat Pump 400/2, 500/2, 750/2 and 1000/2

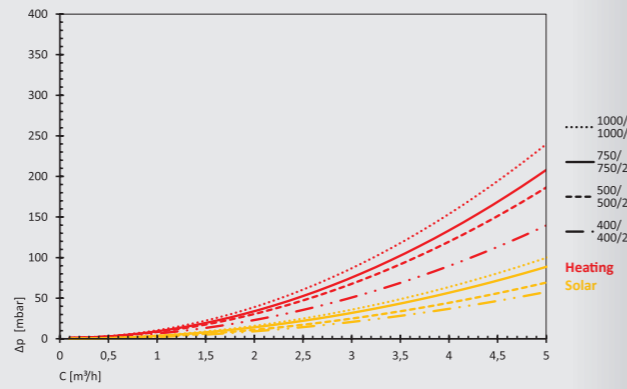

Performance charts

Storatherm Aqua Heat Pump 1000/1  
Temperature at tapping point: 45 °C

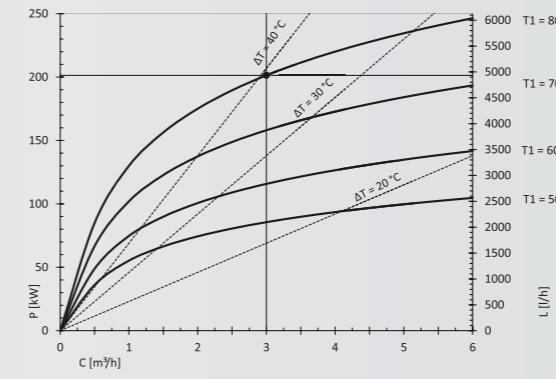

Storatherm Aqua Heat Pump 300/2  
Temperature at tapping point: 45 °C

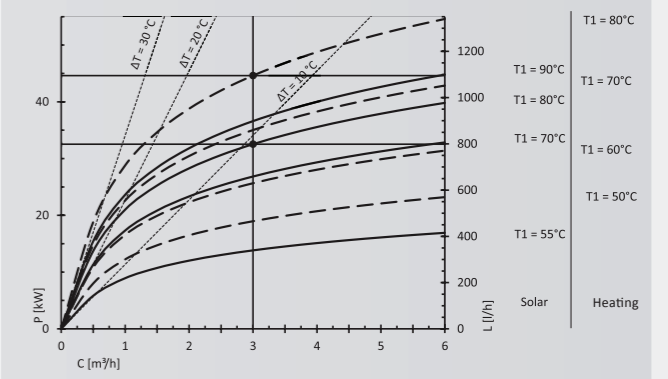

Performance charts

Storatherm Aqua Heat Pump 300/1  
Temperature at tapping point: 60 °C

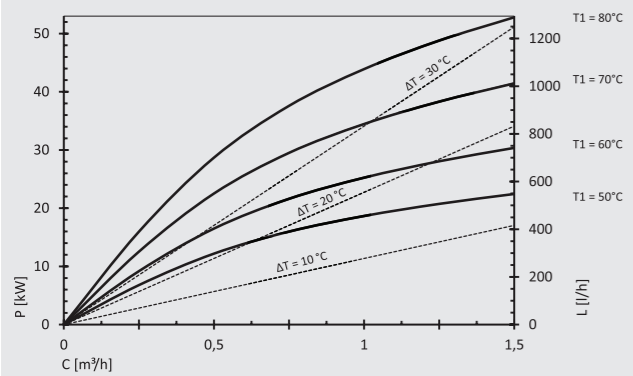

Storatherm Aqua Heat Pump 400/1  
Temperature at tapping point: 60 °C

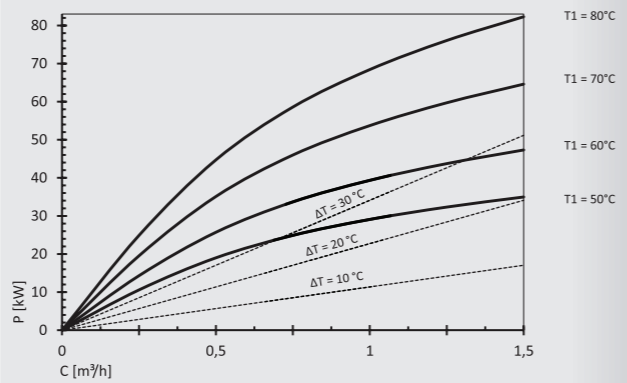

Storatherm Aqua Heat Pump 400/2  
Temperature at tapping point: 45 °C

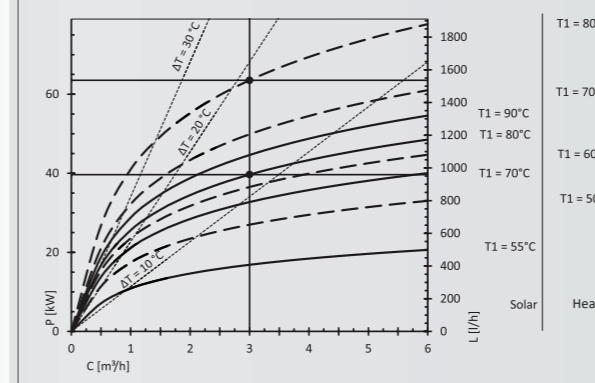

Storatherm Aqua Heat Pump 500/2  
Temperature at tapping point: 45 °C

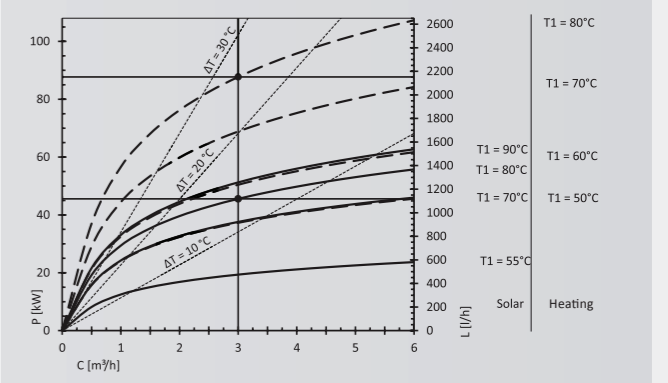

Storatherm Aqua Heat Pump 500/1  
Temperature at tapping point: 60 °C

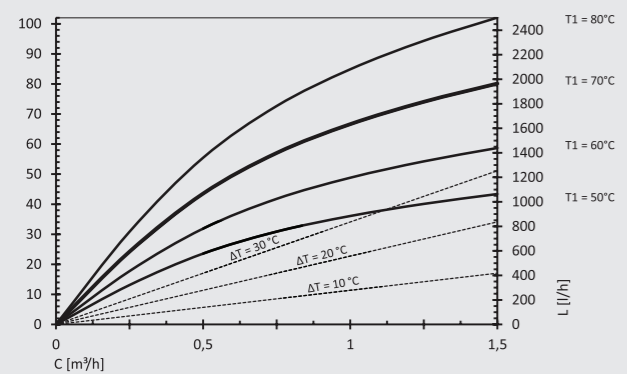

Storatherm Aqua Heat Pump 750/1  
Temperature at tapping point: 45 °C

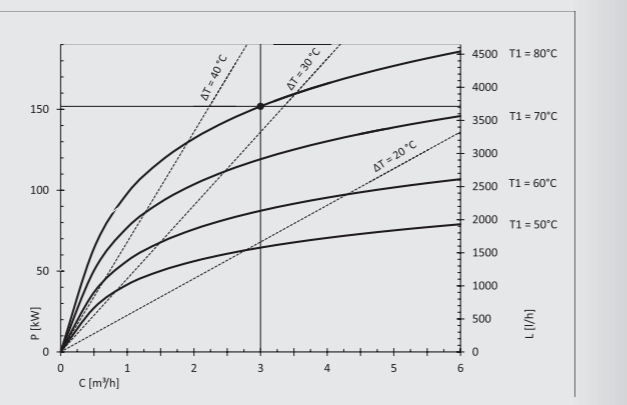

Storatherm Aqua Heat Pump 750/2  
Temperature at tapping point: 45 °C

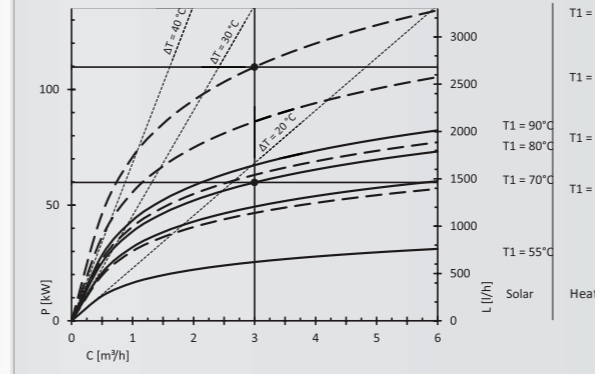

Storatherm Aqua Heat Pump 1000/2  
Temperature at tapping point: 45 °C

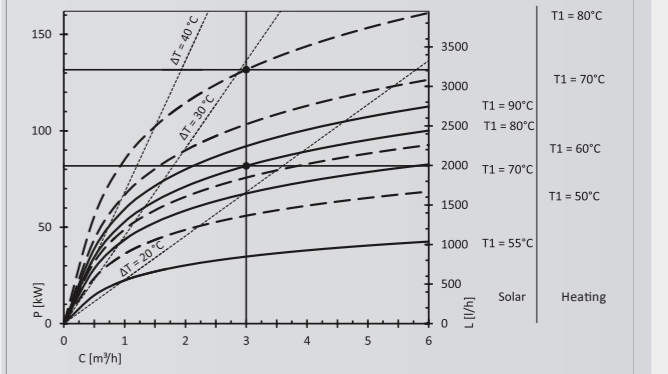



# Storatherm Aqua Compact storage water heater for hot water preparation

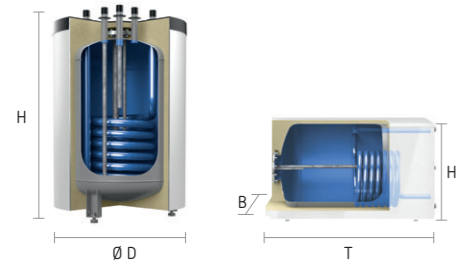

AC 120/1 and AC 160/1 AC 150/1 and 250/1

### Technical features

- In compact series for all heating systems
- Enamelling executed in accordance with DIN 4753-3, with magnesium anode, thermometer and insulated delivery
- Maximum operating overpressure: heating water 16 bar, potable water 10 bar
- Maximum operating temperature: heating water 110 °C, potable water 95 °C

### Type overview

**AC 120/1**  
Compact tank with connections at the top for assembly directly below a wall-hung heater

**AC ... /1**  
Base tank for space-saving boiler/tank combinations with one heating coil, load capacity up to 300 kg

**Insulation**  
rECOflex® insulation system with foil jacket, non-removable

**Insulation**  
rECOflex® insulation system with sheet steel cladding, non-removable

Type	Prod. no.		Content [l]	Ø D with ins. [mm]	Height H with ins. [mm]	Tilted dimension [mm]	Depth T [mm]	Output				Standing losses W	EEC
	white	silver						$N_L^{1)}$	kW	l/h	V40		
<b>Storatherm Aqua Compact, connections at the top</b>													
AC120/1_B	7850100	-	120	560	800	980	-	1.4	22	540	-	53	B
AC160/1_C	7862850	-	146	560	1.036	1.132	-	-	-	-	-	62	C
<b>Storatherm Aqua Compact, horizontal</b>													
AC150/1_B	7862800	7863100	150	620	590	-	1,045	3.6	29	708	231	41	B
AC250/1_B	7862900	7863200	250	653	644	-	1,125	7.6	29	714	386	61	B

### Geometric data: Storatherm Aqua Compact

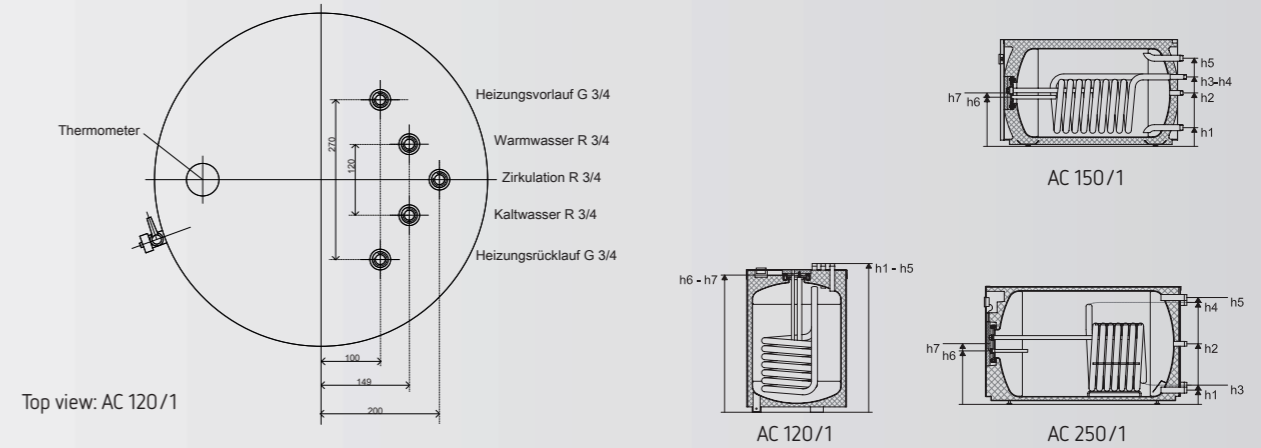

Type		AC 120/1	AC 150/1	AC 250/1	
Technical data	Weight	kg	56	85	114
	Hot water, WW	R	¾	1	1
		h5	mm	835	485
	Cold water, KW	R	¾	1	1
		h1	mm	835	95
	Circulation, Z	R	¾	¾	¾
		h2	mm	835	290
	Heating flow, HV	R	¾	¾	1
		h4	mm	835	380
	Heating return flow, HR	R	¾	¾	1
		h3	mm	835	380
	Sensor tube	Ø i x mm	16 x 385	16 x 250	16 x 200
		h6	mm	835	265
	Blind flange	DN	85	110	150
LK		125	150	180	
Anode		1 x Mg	1 x Mg	1 x Mg	
Heating surface	m <sup>2</sup>	0.71	0.9	0.9	
Content, heat exchanger	l	4.5	5.7	5.66	
Insulation thickness	mm	30	45	30	
Max. operating pressure heating water	bar	10	10	10	
Max. operating pressure potable water	bar	10	10	10	
Max. operating temp. heating water	°C	110	110	110	
Max. operating temp. potable water	°C	95	95	95	

Subject to technical modifications | FSA = impressed-current anode, Mg = magnesium anode, EEHR = electro screw-in heater, EFHR = electro flange heater

Information on output subject to heating water supply temperature and heating water flow rate. Continuous output at: heating water flow rate = 3 m<sup>3</sup>, t<sub>flow</sub> = 80 °C, t<sub>cold</sub> = 10 °C, t<sub>ww</sub> = 45 °C

<sup>1)</sup> Performance index N<sub>L</sub> in accordance with DIN 4708 for storage heating t<sub>s</sub> to 60 °C:  
 t<sub>s</sub> = 60 °C → 1.00 x N<sub>L</sub>    t<sub>s</sub> = 50 °C → 0.55 x N<sub>L</sub>  
 t<sub>s</sub> = 55 °C → 0.75 x N<sub>L</sub>    t<sub>s</sub> = 45 °C → 0.30 x N<sub>L</sub>

Pressure losses

Storatherm Aqua Compact 120/1, 150/1 and 250/1

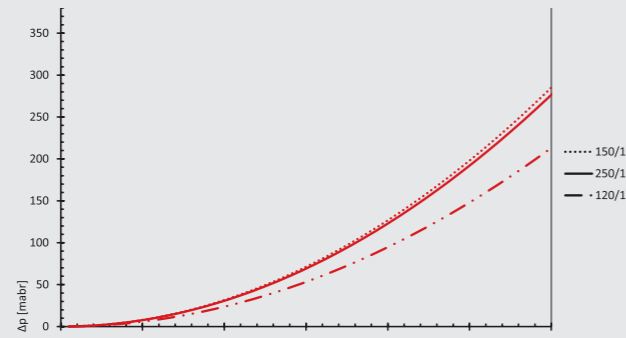

Performance charts

Storatherm Aqua Compact 120/1  
Temperature at tapping point: 45 °C

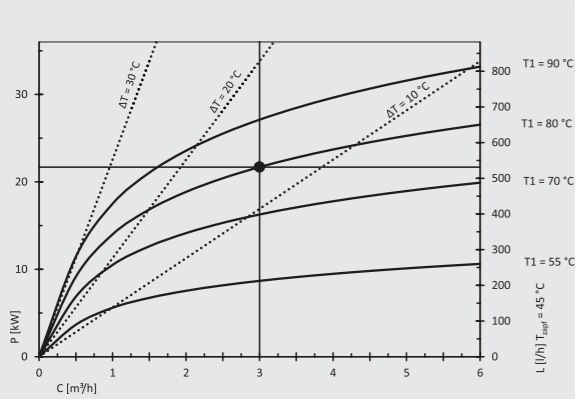

Storatherm Aqua Compact 150/1  
Temperature at tapping point: 45 °C

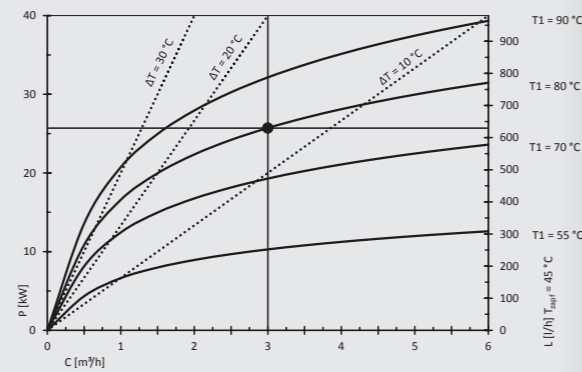

Storatherm Aqua Compact 250/1  
Temperature at tapping point: 45 °C

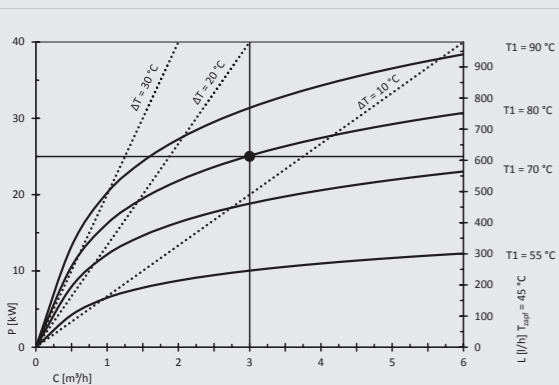

Storatherm Aqua Compact wall-hung storage water heater

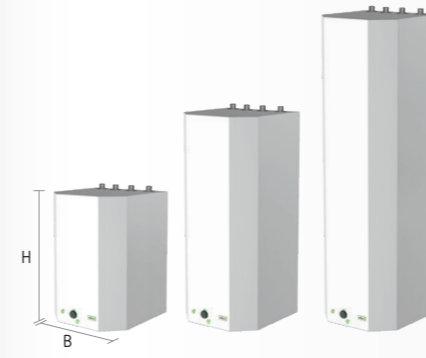

AC .../1-W; AC .../1E-W; AC .../E-W

Technical features

- Wall-hung tanks in compact design; can be used with all conventional energy sources
- E-version with high-grade ceramic heating element without contact with potable water sheet steel housing with rECOflex® insulation system
- For AC.../1E-W and AC.../E-W:  
output 3,000 W at 400 V or 1,000 W at 230 V  
Regulating range: 7 °C - 85 °C, switches off at 110 °C
- Maximum operating overpressure: heating water 10 bar, potable water 10 bar
- Maximum operating temperature: heating water 110 °C, potable water 95 °C

Type overview



AC .../1-W  
Potable water storage tank for wall-mounting with one heating coil  
**Insulation**  
rECOflex® insulation system with sheet steel cladding



AC .../1E-W  
Potable water storage tank with one heating coil and electric heater  
**Insulation**  
rECOflex® insulation system with sheet steel cladding



AC .../E-W  
Potable water storage tank for wall-mounting with electric heater  
**Insulation**  
rECOflex® insulation system with sheet steel cladding

Type	Prod. no.	Content	Breadth B	Height H with ins.	Output			Standing losses	EEC
					$N_L^{1)}$	kW	l/h		
Storatherm Aqua Compact AC .../1-W_C									
AC 60/1-W_B	7760200	67	461	700	1	18	440	38	B
AC 110/1-W_B	7760300	112	461	1,065	1.5	23	566	48	B
AC 160/1-W_C	7761800	171	461	1,492	2.2	23	566	63	C
Storatherm Aqua Compact AC .../1E-W_C									
AC 60/1E-W_B	7760220	65	461	700	1	18	440	38	B
AC 110/1E-W_B	7760320	110	461	1,065	1.5	23	566	48	B
AC 160/1E-W_C	7761820	164	461	1,492	2.2	23	566	63	C
Storatherm Aqua Compact AC .../E-W_C									
AC 60/E-W_B	7760210	71	461	700	-	-	-	38	B
AC 110/E-W_B	7760310	117	461	1,065	-	-	-	48	B
AC 160/E-W_C	7761810	171	461	1,492	-	-	-	63	C

Information on output subject to heating water supply temperature and heating water flow rate. Continuous output at:  
heating water flow rate = 3 m³,  $t_{\text{flow}} = 80^\circ\text{C}$ ,  $t_{\text{cold}} = 10^\circ\text{C}$ ,  $t_{\text{ww}} = 45^\circ\text{C}$

<sup>1)</sup> Performance index  $N_L$  in accordance with DIN 4708 for storage heating  $t_s$  to 60 °C:  
 $t_s = 60^\circ\text{C} \rightarrow 1.00 \times N_L$      $t_s = 50^\circ\text{C} \rightarrow 0.55 \times N_L$   
 $t_s = 55^\circ\text{C} \rightarrow 0.75 \times N_L$      $t_s = 45^\circ\text{C} \rightarrow 0.30 \times N_L$

Geometric data: Storatherm Aqua Compact, wall-hung

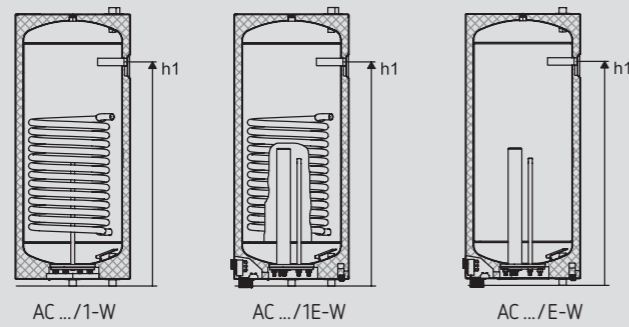

Type		AC 60/1-W	AC 110/1-W	AC 160/1-W	AC 60/1E-W	AC 110/1E-W	AC 160/1E-W	AC 60/E-W	AC 110/E-W	AC 160/E-W
Weight		52	65	91	58	71	97	51	64	90
Height, wall-mounting	h1	533	855	1,225	533	855	1,225	533	855	1,225
Hot water, WW	R	¾	¾	¾	¾	¾	¾	¾	¾	¾
Cold water, KW	R	¾	¾	¾	¾	¾	¾	¾	¾	¾
Heating flow, HV	R	¾	¾	¾	¾	¾	¾	-	-	-
Heating return flow, HR	R	¾	¾	¾	¾	¾	¾	-	-	-
Anode		1 x Mg	1 x Mg	1 x Mg	1 x Mg	1 x Mg	1 x Mg	1 x Mg	1 x Mg	1 x Mg
Heating surface	m <sup>2</sup>	0.75	0.95	0.95	0.75	0.95	0.95	-	-	-
Content, heat exchanger	l	3.6	4.7	4.7	3.6	4.7	4.7	-	-	-
Insulation thickness	mm	30	30	30	30	30	30	30	30	30
Voltage (alternatively)	U V	-	-	-	400 (230)	400 (230)	400 (230)	400 (230)	400 (230)	400 (230)
Output (alternatively)	P W	-	-	-	3,000 (1,000)	3,000 (1,000)	3,000 (1,000)	3,000 (1,000)	3,000 (1,000)	3,000 (1,000)
Regulating range	°C	-	-	-	7-85	7-85	7-85	7-85	7-85	7-85
Switches off	°C	-	-	-	110	110	110	110	110	110
Flange	TK mm	150	150	150	150	150	150	150	150	150

Subject to technical modifications | FSA = impressed-current anode, Mg = magnesium anode, EEHR = electro screw-in heater, EFHR = electro flange heater

Pressure losses

Storatherm Aqua Compact, wall-hung  
60/1, 110/1 and 160/1

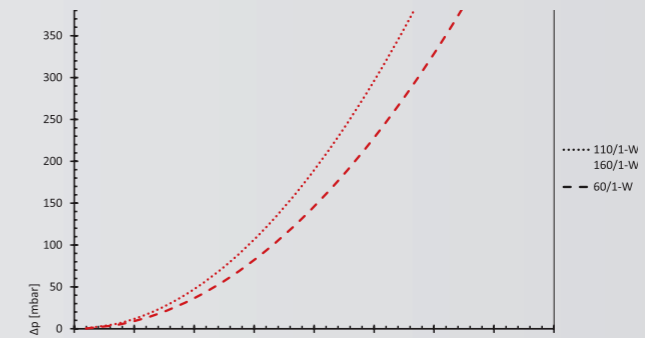

Performance charts

Storatherm Aqua Compact, wall-hung AC 60/1-W  
Temperature at tapping point: 45 °C

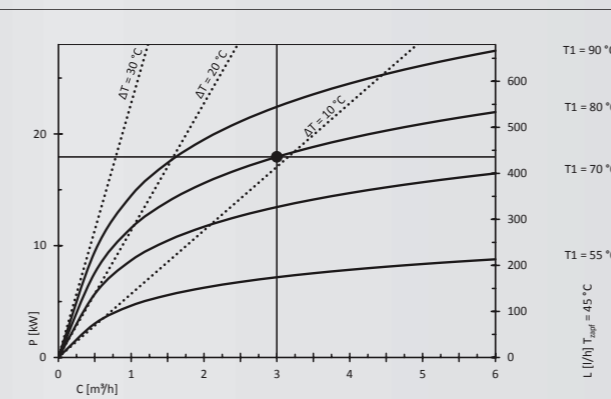

Storatherm Aqua Compact, wall-hung 60/1  
Temperature at tapping point: 60 °C

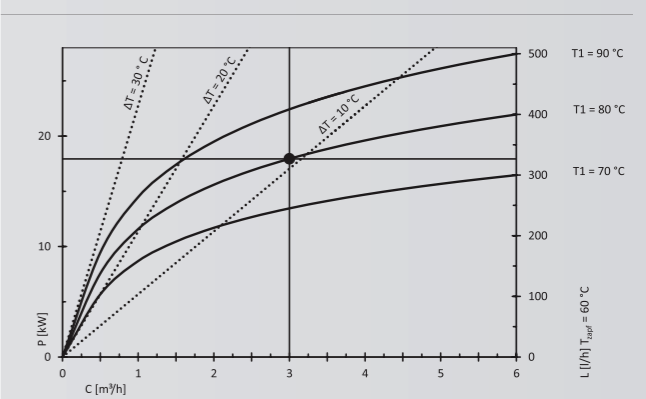

Storatherm Aqua Compact, wall-hung 110/1  
Temperature at tapping point: 60 °C

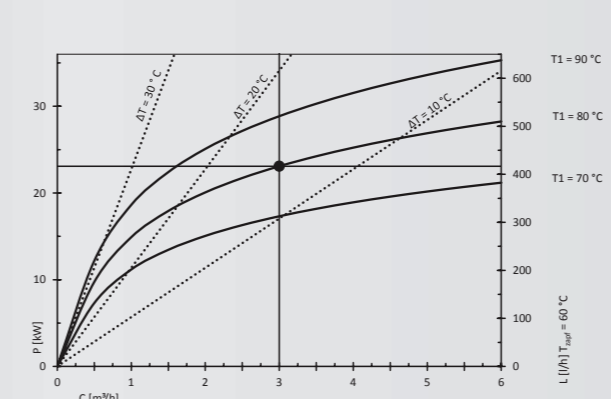

Storatherm Aqua Compact, wall-hung 160/1  
Temperature at tapping point: 60 °C

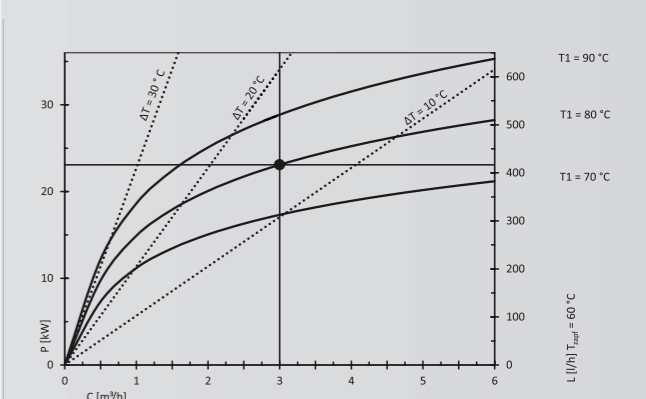



# Storatherm Aqua Load charge water tank

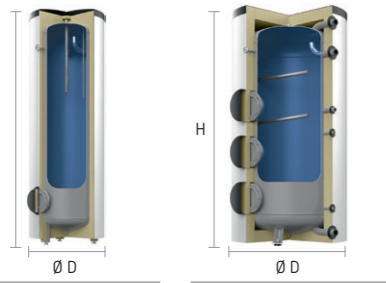

R – 1 flange  
AL 300–500/R

R3 – 3 flanges  
AL 1500–3000/R3

### Technical features

- For hot water preparation in the tank primary store system
- Enamelling executed in accordance with DIN 4753-3
- Magnesium anode, thermometer, adjustable feet
- Up to four maintenance openings
- Maximum operating overpressure: potable water 10 bar
- Maximum operating temperature: potable water 95°C

### Type overview

<p><b>AL .../R</b> Potable water storage tank with one inspection flange <b>Insulation</b> Up to 500 litres: reCOflex® insulation system with foil jacket, non-removable From 750 litres: 100 mm fleece insulation with foil jacket, removable</p>	<p><b>AL .../R2</b> Potable water storage tank with two inspection flanges <b>Insulation</b> 120 mm fleece insulation with foil jacket, removable</p>	<p><b>AL .../R3</b> Potable water storage tank with three inspection flanges <b>Insulation</b> 120 mm fleece insulation with foil jacket, removable</p>	<p><b>AL .../R4</b> Potable water storage tank with four inspection flanges <b>Insulation</b> 120 mm fleece insulation with foil jacket, removable</p>
--	---	---	--

Type	Prod. no.	Content	Ø D without / with ins. [mm]	Height H without / with ins. [mm]	Tilted dimension [mm]	Standing losses W	EEC
Storatherm Aqua Load AL .../R							
AL 300/R_C	7844400	301	600	1,834	1,892	83	C
AL 500/R_C	7844500	477	700	1,958	2,044	100	C
AL 750/R_C	7844600	751	750/950	1,917/2,035	1,990	123	C
AL 1000/R_C	7844700	972	850/1,050	1,934/2,060	2,025	142	C
Storatherm Aqua Load AL .../R2							
AL 300/R2_C	7353100	301	600	1,834	1,892	83	C
AL 500/R2_C	7353200	477	700	1,958	2,044	100	C
AL 750/R2_C	7353300	751	750/950	1,917/2,035	1,990	123	C
AL 1000/R2_C	7353400	972	850/1,050	1,934/2,060	2,025	142	C
AL 1500/R2_C	7844800	1,459	1,000/1,240	2,122/2,215	2,200	171	C
AL 2000/R2_C	7844900	1,986	1,200/1,440	2,033/2,126	2,235	188	C
AL 3000/R2	7845000	2,780	1,200/1,440	2,800/2,876	2,848	–	–
Storatherm Aqua Load AL .../R3							
AL 1500/R3_C	7845100	1,459	1,000/1,200	2,122/2,215	2,220	171	C
AL 2000/R3_C	7845200	1,986	1,200/1,440	2,033/2,126	2,235	188	C
AL 3000/R3	7845300	2,780	1,200/1,440	2,800/2,876	2,848	–	–
Storatherm Aqua Load AL .../R4							
AL 3000/R4	7845400	2,780	1,200/1,440	2,800/2,876	2,848	–	–
AL 4000/R4	7845480	4,040	1,500/1,740	2,721/2,841	2,845	–	–
AL 5000/R4	7845490	4,914	1,500/1,740	3,230/3,350	3,311	–	–

### Geometric data: Storatherm Aqua Load

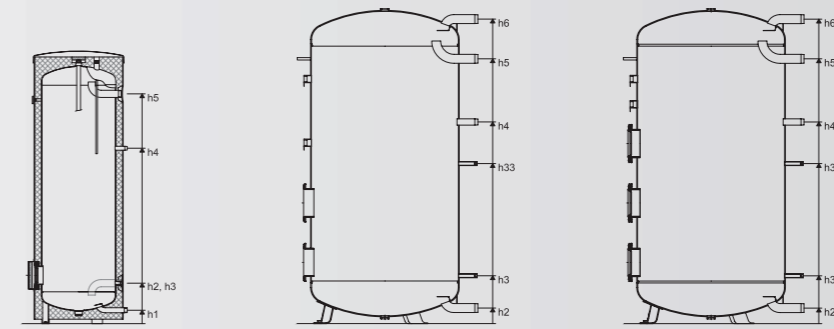

AL .../R

AL .../R2

AL .../R3

Technical data	Type	AL 300/R		AL 500/R		AL 750/R		AL 1000/R		AL 1500/R		AL 2000/R		AL 3000/R		AL 4000/R		AL 5000/R	
		R	AL 300/R2	R	AL 500/R2	R	AL 750/R2	R	AL 1000/R2	R	AL 1500/R2	R	AL 2000/R2	R	AL 3000/R2	R	AL 4000/R4	R	AL 5000/R4
Weight		kg	90	155	214	267	390/395	550/555	690/635	690/635	939	1,070							
Tank charging, L	R		1 ½	1 ½	2	2	2	2	2	2	2	3	3						
	h6	mm	1,546	1,674	1,893	1,910	2,049	1,933	2,691	2,691	2,190	2,663							
Hot water, WW	R		1 ½	1 ½	2	2	2	2	2	2	3	3							
	h5	mm	1,546	1,674	1,642	1,650	1,782	1,648	2,406	2,406	2,178	2,663							
Cold water, KW	R		1 ½	1 ½	2	2	2	2	2	2	3	3							
	h2	mm	272	238	101	100	105	118	235	235	500	510							
Circulation	R		¾	¼	¼	¼	¼	¼	¼	¼	¼	¼							
	h4	mm	1,180	1,265	1,147	1,155	1,357	1,388	1,966	1,966	1,719	2,119							
Sensor tube		Ø i x mm	10 x 614	10 x 656	G ½	Rp ½	G ½	G ½	Rp ½	Rp ½	Rp ½	Rp ½							
	h3	mm	272	238	292	300	322	353	391	391	449	449							
	h33	mm	1,794	1,921	947	955	1,077	1,108	1,546	1,546	–	–							
Draining	R		1	1	–	–	–	–	–	–	–	–							
	h1	mm	90	55	–	–	–	–	–	–	–	–							
Blind flange	DN		110	110	180	180	180	180	180	180	180	180							
	LK		150	150	225	225	225	225	225	225	225	225							
Anode			1 x Mg	1 x Mg	1 x Mg	1 x Mg	2 x Mg	2 x Mg	2 x Mg	2 x Mg	3 x Mg	4 x Mg							
Insulation thickness	mm		50	50	100	100	120	120	120	120	120	120							
Max. installation length, EFHR	mm		395	495	610	740	740	740	900	900	900	900							

Subject to technical modifications | FSA = impressed-current anode, Mg = magnesium anode, EEHR = electro screw-in heater, EFHR = electro flange heater



Storatherm Aqua Inox stainless steel potable water storage tank

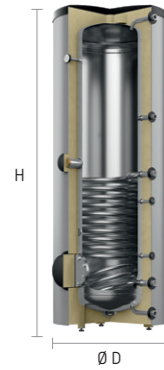

Technical features

- For all heating systems with one heating coil
- Made using high-grade stainless steel
- rECOflex® insulation system with foil jacket
- With 1 1/2" sleeve
- Max. operating pressure: heating water 10 bar, potable water 10 bar
- Max. operating temperature: heating water 130 °C, potable water 90 °C

AI .../1M

Type overview



AI .../1M  
Stainless steel potable water storage tank with one heating coil

Insulation  
rECOflex® insulation system with foil jacket, non-removable

Type	Prod. no.	Content	Ø D with ins.	Height H with ins.	Tilted dimension	Output				Standing losses	EEC
						N <sub>L</sub> <sup>1)</sup>	kW	l/h	V40		
AI 150/1M_A	7364100	150	600	1,211	1,279	3.1	33	804	258	38	A
AI 200/1M_B	7364200	190	600	1,474	1,524	5.8	49	1,207	321	44	B
AI 300/1M_B	7364300	295	700	1,833	1,881	11.2	59	1,453	500	57	B
AI 400/1M_B	7364400	375	750	1,630	1,719	13.6	62	1,504	545	61	B
AI 500/1M_B	7364500	475	750	2,000	2,066	18.1	70	1,710	742	72	B

Geometric data: Storatherm Aqua Inox

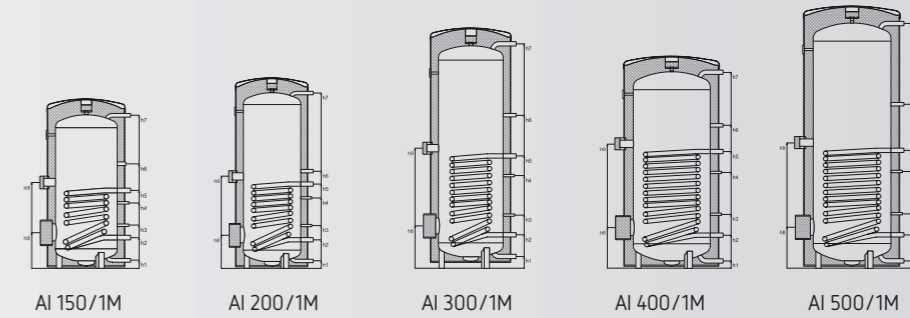

Type		AI 150/1M	AI 200/1M	AI 300/1M	AI 400/1M	AI 500/1M	
Weight*		kg	35	43	58	68	80
	Hot water, WW	R	¾"	¾"	1"	1"	1"
Cold water, KW	h7	mm	1,114	1,373	1,733	1,528	1,889
	R		¾"	¾"	1"	1"	1"
Heating flow, HV	h1	mm	55	55	91	57	57
	R		1"	1"	1"	1"	1"
Heating return flow, HR	h5	mm	566	661	867	910	910
	R		1"	1"	1"	1"	1"
Circulation, Z	h2	mm	223	223	258	258	258
	R		¾"	¾"	¾"	¾"	¾"
Sensor tube, heating, F1	h3	mm	476	551	715	747	747
Sensor tube, solar, F2	h4	mm	313	333	410	421	421
Blind flange, FL	DN	mm	110	110	110	110	110
	ET**	mm	365	365	365	462	462
Sleeve for electric heater	R		1 1/2"	1 1/2"	1 1/2"	1 1/2"	1 1/2"
	ET**	mm	450	450	500	600	600
Potable water volume		l	152.4	190.4	293.6	378.2	477.0
Heating surface		m²	0.8	1.1	1.4	1.6	1.8
Content, heat exchanger		l	5.2	7.0	8.8	10.0	11.6
Insulation thickness		mm	75	75	75	75	75
Max. operating overpressure heating water/potable water		bar	10/10	10/10	10/10	10/10	10/10
Max. operating temperature heating water/potable water		°C	130/90	130/90	130/90	130/90	130/90

Subject to technical modifications | FSA = impressed-current anode, Mg = magnesium anode, EEHR = electro screw-in heater, EFHR = electro flange heater

Information on output subject to heating water supply temperature and heating water flow rate. Continuous output at: heating water flow rate = 3 m³, t<sub>flow</sub> = 80 °C, t<sub>cool</sub> = 10 °C, t<sub>ww</sub> = 45 °C

<sup>1)</sup> Performance index N<sub>L</sub> in accordance with DIN 4708 for storage heating t<sub>s</sub> to 60 °C:  
 t<sub>s</sub> = 60 °C → 1.00 x N<sub>L</sub>    t<sub>s</sub> = 50 °C → 0.55 x N<sub>L</sub>  
 t<sub>s</sub> = 55 °C → 0.75 x N<sub>L</sub>    t<sub>s</sub> = 45 °C → 0.30 x N<sub>L</sub>



# Selection and calculation

## Dimensioning potable water storage tanks for residential buildings

### General information

Similar to buffer storage tanks, potable water storage tanks separate demand from the supply of heat and thus serve as storage tanks. They separate potable water from the heat source and in so doing prevent contamination or germ formation.

<b>Principles of dimensioning</b>	<b>Potable water storage tanks are selected and designed according to the</b>	
	<ul style="list-style-type: none"> <li>→ amount of energy stored in the tank</li> <li>→ type of heat generation (e.g. furnace, solar collectors, CHP)</li> <li>→ individual need for hot water</li> </ul>	<ul style="list-style-type: none"> <li>→ charging and discharging capacities and charging and discharging times</li> <li>→ hydraulic aspects (e.g. pressure and temperature conditions)</li> </ul>
<b>Dimensioning in accordance with DIN 4708</b>	<p>DIN 4708 can be referenced for the dimensioning of potable water storage tanks. This standard refers to residential buildings with mixed occupancy, meaning the residents have different hot water requirements. Peaks in demand are reduced and the withdrawal times spread over longer periods. For commercial</p>	<p>buildings and those with short peaks in demand for hot water, such as industrial plants, nursing homes and restaurants, the amount of heat to be stored must be calculated using other methods, e.g. the hydrograph superposition method.</p>
<b>Standard flat</b>	<p>DIN 4708 defines a standard flat to be for 3.5 residents with four rooms. This flat has two draw-off points and a 140-litre bathtub. Each standard flat is evaluated using the demand index <math>N = 1</math>.</p>	<p>The individual demand index states that the hot water requirement of the building corresponds to <math>N</math> times the demand of a standard flat. The energy needed for hot water preparation in a standard flat is estimated at <math>3.5 \cdot 5820 \text{ Wh} = 20370 \text{ Wh}</math>.</p>
<b>Demand index</b>	<p>The demand index <math>N</math> describes the number of standard flats in the building being assessed. It can be calculated using the below formula:</p>	<p><math>n</math> Number of flats (the number of identical living units to be supplied)</p> <p><math>p</math> Number of occupants (the number of residents per flat according to the developer or using the table in DIN)</p> <p><math>v</math> Number of draw-off points (the number of draw-off points for hot water, such as bathtub, shower and wash basin in each flat)</p> <p><math>w_v</math> Draw-off points required (the heat quantity in Wh for drawing hot water from one draw-off point)</p>
	$N = \sum (n \cdot p \cdot v \cdot w_v) / p \cdot w_v$	
<b>Characteristics of potable water storage tanks</b>	<b>Concurrent selection criteria:</b>	
	<ul style="list-style-type: none"> <li>→ Usable heat quantity in kJ or kWh</li> <li>→ Tank size (nominal volume) in l</li> <li>→ Utilisation ratio</li> </ul>	<ul style="list-style-type: none"> <li>→ Dimensions and connections</li> <li>→ Auxiliary heating, e.g. electric heating element</li> </ul>

### Sample schematic

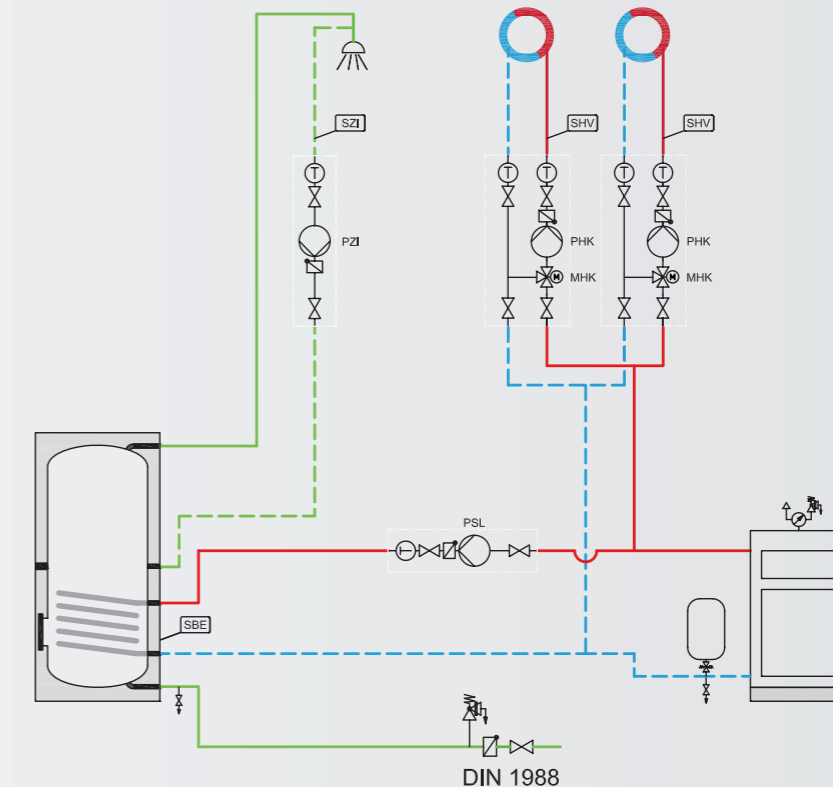

Reflex Storatherm Aqua, heat generator, circulation, 2 HK

### Quick selection of potable water tanks

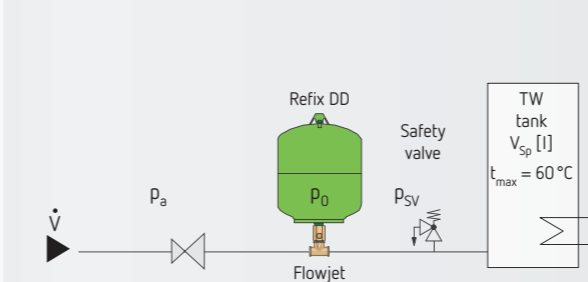

V <sub>sp</sub> [l]	Safety valve [bar]		
	6	8	10
100	DD 12	DD 8	DD 8
150	DD 18	DD 8	DD 8
200	DD 18	DD 12	DD 8
250	DD 25	DD 12	DD 12
300	DD 25	DD 18	DD 12
400	DD 33	DD 18	DD 18
500	2 x DD 25	DD 25	DD 18
600	2 x DD 25	DD 25	DD 25
700	2 x DD 33	DD 33	DD 25

The use of a Flowjet flow through valve is recommended!  
 Max. peak volume flow at:  
 DD (¾") < 2.5 m³/h; at DD (1") < 4.2 m³/h

Gas inlet pressure  $p_0 = 4.0 \text{ bar (standard)}$   
 Pressure reducer set-point pressure  $p_a \geq 4.2 \text{ bar}$

## Dimensioning potable water storage tanks in practise

**For your information** You can roughly estimate the tank size in residential buildings by considering the number of people and their washing habits.

### Calculating the tank size

According to DIN 4708-2, you can determine the individual demand index N by evaluating the individual flats. From demand index and desired temperature in the tank you can calculate the required heat quantity in kWh. If you use solar energy for heat generation, increase the amount of heat to be stored by a factor of two, for example. The buffer storage tank must be capable of offsetting temporal fluctuations due to changing sunlight.



### Draw-off points and their heat demand

Abbreviation	Draw-off point designation	W <sub>v</sub> in Wh	V <sub>E</sub> in L
NB1	Bathtub	5,820	140
NB2	Bathtub	6,510	160
KB	Small tub	4,890	120
GB	Large tub	8,720	200
BRS	Shower with mixer tap	1,630	40
BRN	Standard shower	3,660	90
RRL	Luxury shower	7,320	180
WT	Washstand	700	17
BD	Bidet	810	20
HAT	Washbasin	350	9
SP	Sink	1,160	30



### Potable water storage tank data

Type	Prod. no.		Content [l]	Dimensions [mm]	Height with ins. [mm]	Tilted dimension [mm]	Output				EEC
	white	silver					N <sub>L</sub> <sup>1)</sup>	kW	l/h	V40	
Storatherm Aqua AF ... /1M_A rECOflex <sup>®</sup> insulation system with foil jacket											
AF 150/1M_A	7355100	7350100	159	650x650	1,068	1,212	2.4	25	615		A
AF 200/1M_A	7355200	7350200	197	650x650	1,260	1,384	4.2	31	760		A



**For systems with boiler output < 20 kW:**  
50 litres/person when they bath predominantly  
25 litres/person when they shower predominantly

**For systems with boiler output > 20 kW:**  
30 litres/person when they bath predominantly

### DIN 4708-2 form

Record the demand data of the flats in the form provided in DIN 4708-2. Group together flats that are designed and used similarly.



Hot water demand of centrally supplied flats									
Project: Responsible:					Date: DD/MM/YYYY Sheet no.:				
Calculation of the demand index N for determining the size of the storage water heater									
1	2	3	4	5	6	7	8	9	10
Seq. no. of flat groups	Number of rooms	Number of flats	Number of occupants		Number of draw-off points	Brief description	Draw-off points required [Wh]	Number of draw-off points x draw-off points required [Wh]	[Wh]
	r	n	p	n * p	z		w <sub>v</sub>	z * w <sub>v</sub>	n * p * Σw <sub>v</sub>
				3 * 4				6 * 8	5 * 9
1	4	1	3.5	3.5	1	NB 1	5,820	5,820	20,370

Table 1

$$\Sigma(n * p * \Sigma w_v) = 20370 \text{ Wh} \rightarrow N = \frac{\Sigma(n * p * \Sigma w_v)}{3.5 * 5820} = \frac{20370 \text{ Wh}}{20370 \text{ Wh}} \rightarrow N = 1$$

### How to complete the DIN 4708-2 form



1. Classify the different flats in the building to flat groups.
2. Enter the number of rooms per flat in column 2.
3. Determine the number of identical flats and enter in column 3.
4. Define occupancy numbers for the flat group (average number of people per flat) and enter in column 4.
5. Record type and number of draw-off points and their heat demand (see table 1). Create separate rows for each type of draw-off point. Enter the details in columns 6, 7 and 8.
6. Calculate the demand index N (see calculation of the demand index on page 44).
7. Determine the type of tank using the demand index N and the performance index N<sub>L</sub> of the potable water storage tanks. Recommendation: N<sub>L</sub> ≥ N.

## Real-life example — DIN 4708-2 form

1) Specifications

<p><b>A</b> 3 identical flats 2 rooms 2 people 1 standard shower (BRN)</p>	+	<p><b>B</b> 6 identical flats 4 rooms 3 people 1 bathtub (NB1)</p>
--	---	--



### 2) Complete form / Calculate demand index N / N = 7,935

Service water demand according to DIN 4708									
Project: Responsible:					Date: DD/MM/YYYY				
1	2	3	4	5	6	7	8	9	10
Seq. no. of flat	Number of rooms	Number of flats	Number of occupants		Quantity	Brief description	Demand [Wh]	Number of draw-off points x points x draw-off points required [Wh]	[Wh]
	r	n	p	n * p	z		w <sub>v</sub>	z * w <sub>v</sub>	n * p * Σw <sub>v</sub>
				3 * 4				6 * 8	5 * 9
1	2	3	2	6	1	BRN	3,660	3,660	21,960
2	4	6	4	24	1	NB1	5,820	5,820	139,680

Σn = 9

$$\Sigma(n * p * \Sigma w_v) = 161,640 \text{ Wh} \rightarrow N = \frac{\Sigma(n * p * \Sigma w_v)}{3.5 * 5,820} = \frac{161,640 \text{ Wh}}{20,370 \text{ Wh}} \rightarrow N = 7,935$$

### 3) Selection of tank using the N<sub>L</sub> value: AB 300/1 with N<sub>L</sub> 11.1

Type	Prod. no.		Content [l]	Ø D without/with ins. [mm]	Height without/with ins. [mm]	Tilted dimension [mm]	Output				EEC
	white	silver					N <sub>L</sub> <sup>1)</sup>	kW	l/h	V40	
Storatherm Aqua AB ... /1 rECOflex® insulation system with sheet steel cladding											
AB 100/1_C	7895500	7846400	100	512	849	960	1.3	19	480	–	C
AB 150/1_B	7895600	7846500	150	540	1,222	1,290	3	24	606	240	B
AB 200/1_C	7895700	7846600	200	540	1,473	1,530	4.8	30	739	314	C
AB 300/1_B	7895800	7846700	300	700	1,334	1,472	11.1	46	1,123	415	B
AB 400/1_C	7895900	7846800	400	700	1,631	1,738	14	56	1,383	572	C
AB 500/1_C	7896100	7846900	500	700	1,961	2,044	18	56	1,390	739	C

## Typical installations

To enable you, our customer, to plan your system as easily as possible, we have created system diagrams for each type of tank in this chapter. It is important to us that our products are hydraulically

efficient when integrated into your new or existing system. Please contact our service department if the system diagram you need is not available.



### Advice

1. **General information on the system diagrams**  
The figures aim to illustrate the application of the tanks. **The diagrams are examples**, i.e. they do not replace professional planning and are not necessarily exhaustive. Installation advice and instructions for the components, for heat generators in particular, must be strictly observed.
2. **Safety equipment**  
As a general rule, every component in which water can expand significantly must be protected with an expansion vessel and a safety valve, where the state of the art and applicable standards must be taken into account. Accordingly, the potable water storage tank, all heat generators and buffer storage tanks must be protected.
3. **Heat generator**  
As a general rule, the method used to integrate the tank hydraulically must be clarified with the heat generator's manufacturer. A suitable solution must be selected.

## Explanatory example based on the diagrams

Several storage cells can be connected together if a large volume is required. Both the potable water and the heating water sides are normally connected in parallel. The connections must be executed using the 'Tichelmann principle' so that the flow resistances of the tanks match. According to the Tichelmann principle, the liquids used must flow through pipelines of equal length. It is important that the resistances in the individual storage cells are equal.

If the storage cells are charged with only one charging pump, then fittings should be installed on the heating water side in addition to the drinking water side to enable adjustment at a later date. It is more beneficial to assign each tank its own charging pump, as this ensures all storage cells are evenly charged. In addition, the capacities of other tanks are still available if one charging pump fails and small, inexpensive charging pumps available in stock everywhere can be used. The result is a redundant system that guarantees safe operation at all times.

- 01 Cold water (KW)
- 02 Backflow preventer
- 03 Shut-off valve
- 04 Pressure reducer
- 05 Potable water filters
- 06 Draining
- 07 Manometer connection
- 08 Expansion vessel (MAG) for potable water
- 09 Safety valve
- 10 Observable mouth of the blow-off line
- 11 Hot water (WW)
- 12 Heating flow (HV)
- 13 Circulation (ZK)
- 14 Connection for tank's temperature control or temperature controller
- 15 Heating return flow (HR)
- 16 Boiler (HK)

Parallel operation (Tichelmann) of potable water storage tanks schematic diagram

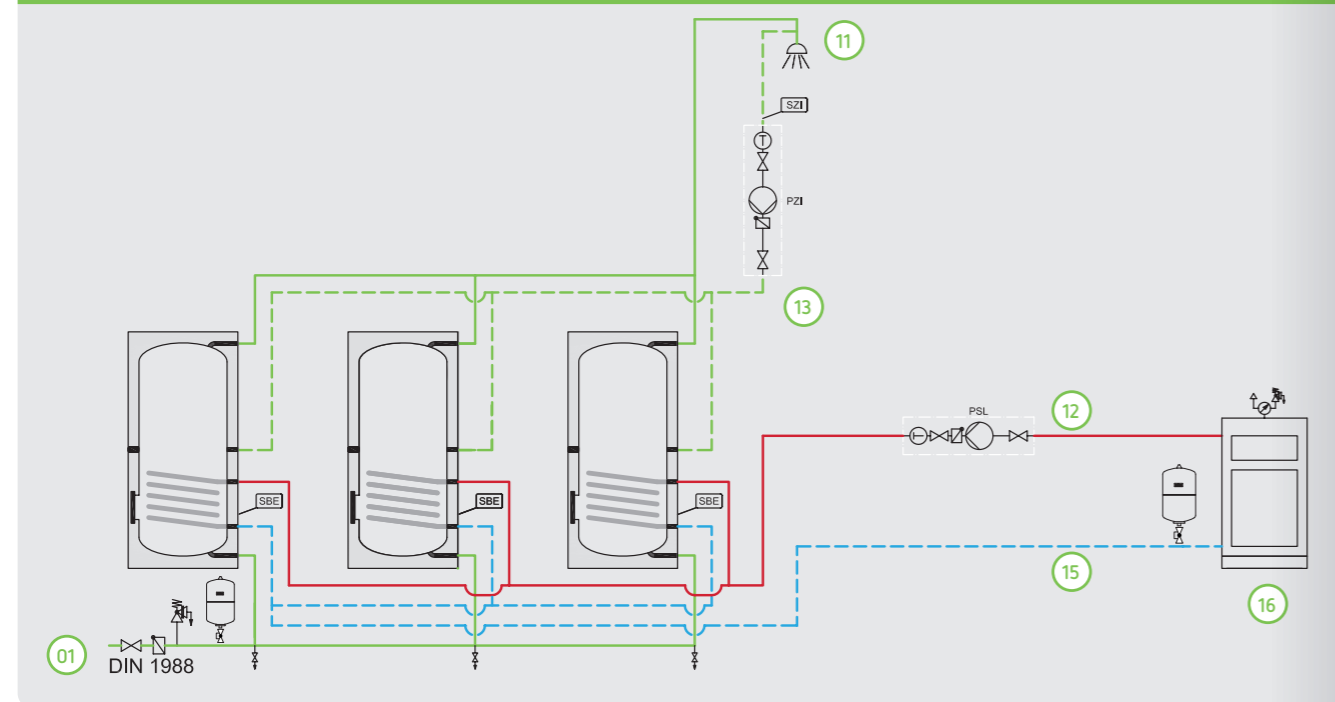

Planning instructions — cold water connection according to DIN 1988

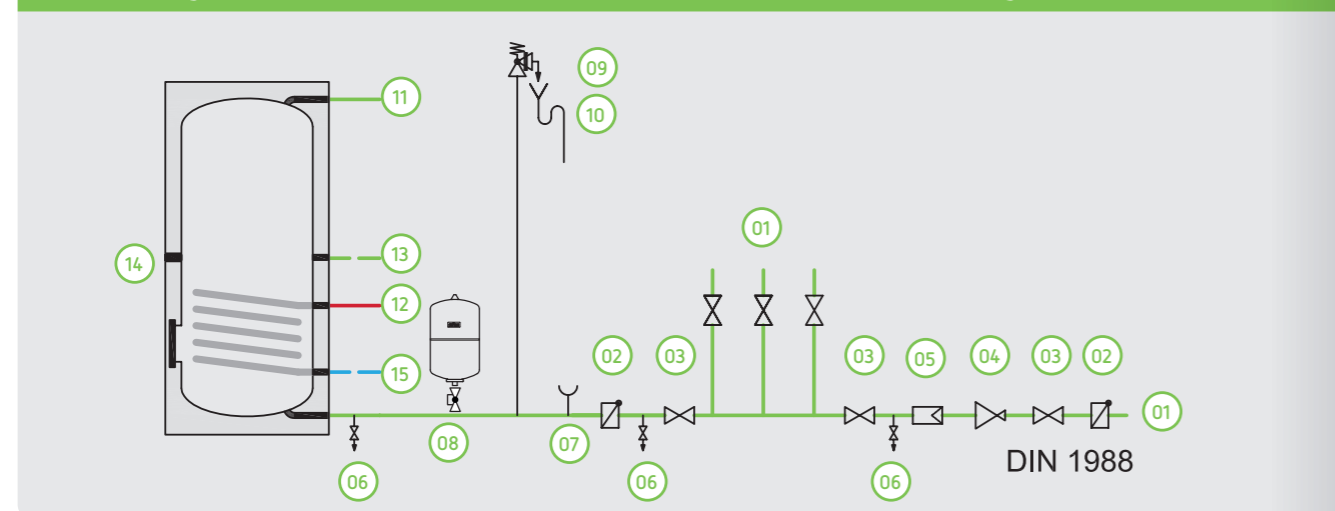

Reflex Storatherm Aqua condensing boiler, circulation, 2 HK

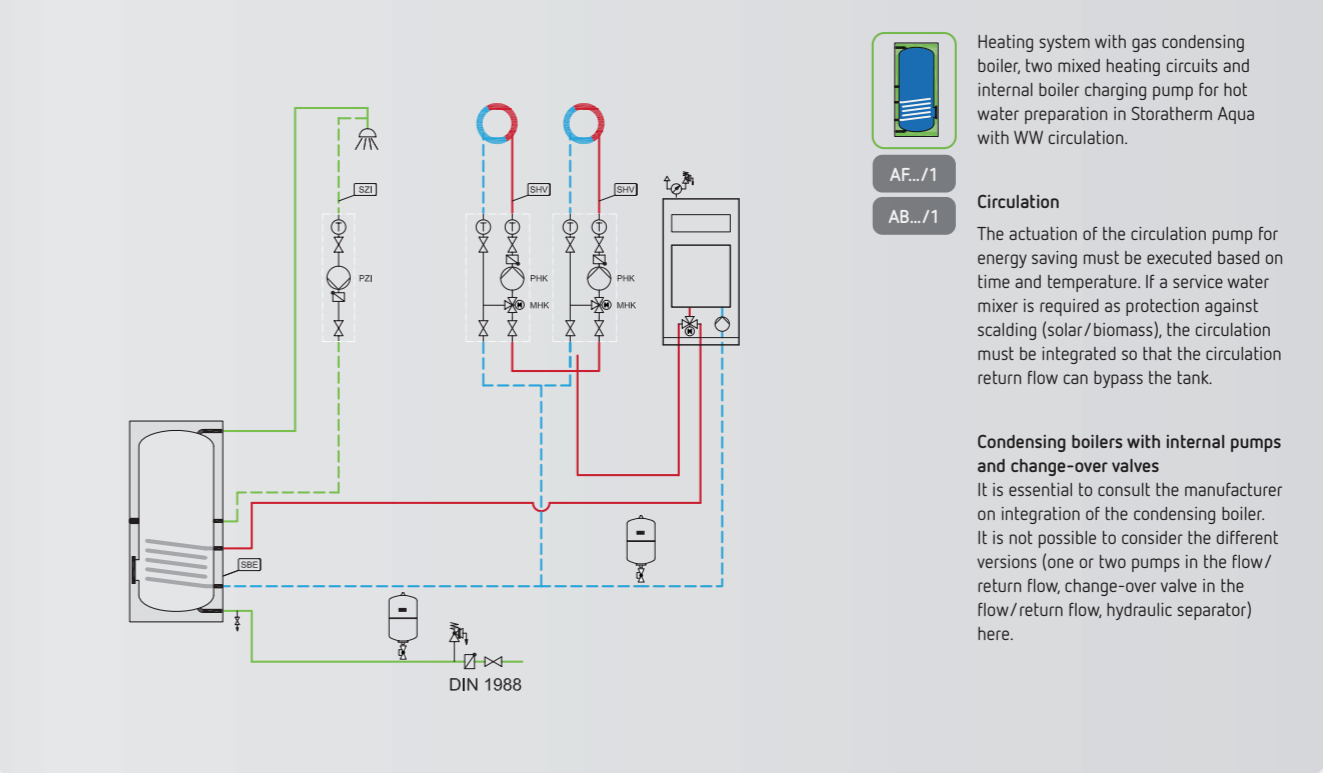

Heating system with gas condensing boiler, two mixed heating circuits and internal boiler charging pump for hot water preparation in Storatherm Aqua with WW circulation.

AF.../1  
AB.../1

**Circulation**  
The actuation of the circulation pump for energy saving must be executed based on time and temperature. If a service water mixer is required as protection against scalding (solar/biomass), the circulation must be integrated so that the circulation return flow can bypass the tank.

**Condensing boilers with internal pumps and change-over valves**  
It is essential to consult the manufacturer on integration of the condensing boiler. It is not possible to consider the different versions (one or two pumps in the flow / return flow, change-over valve in the flow / return flow, hydraulic separator) here.

Storatherm Aqua Solar heat generator, solar system, 2 HK

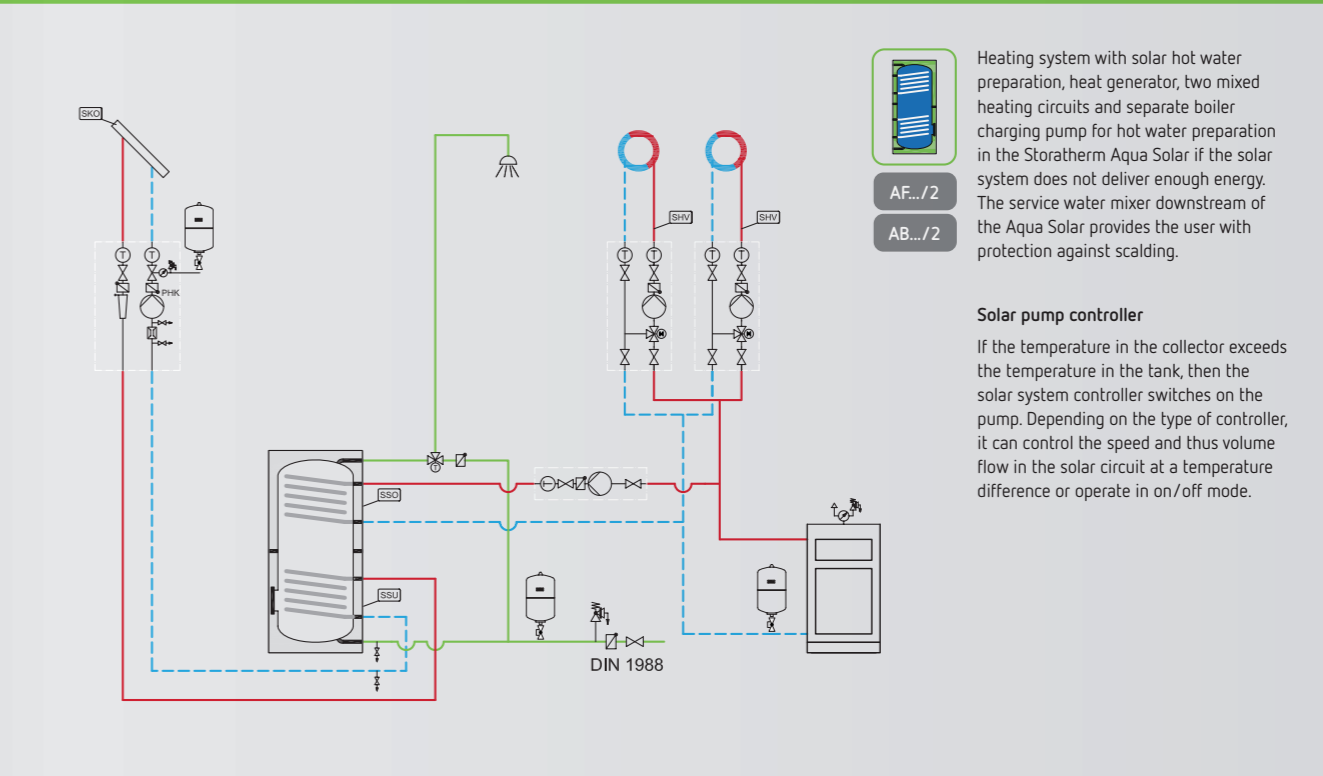

Heating system with solar hot water preparation, heat generator, two mixed heating circuits and separate boiler charging pump for hot water preparation in the Storatherm Aqua Solar if the solar system does not deliver enough energy. The service water mixer downstream of the Aqua Solar provides the user with protection against scalding.

AF.../2  
AB.../2

**Solar pump controller**  
If the temperature in the collector exceeds the temperature in the tank, then the solar system controller switches on the pump. Depending on the type of controller, it can control the speed and thus volume flow in the solar circuit at a temperature difference or operate in on/off mode.

**Reflex Storatherm Aqua Heat Pump** heat pump, circulation, 2 HK, electrical backup

Heating system with heat pump, two mixed heating circuits and separate boiler charging pump for hot water preparation in the Storatherm Aqua Heat Pump with WW circulation. The electro screw-in heater can additionally increase the temperature of the hot water or take over water heating when the heat pump is switched off.



**Circulation**

The actuation of the circulation pump for energy saving must be executed based on time and temperature. If a service water mixer is required as protection against scalding (solar/biomass), the circulation must be integrated so that the circulation return flow can bypass the tank.

**Electric heating for potable water**

There is an increased risk of calcification in extremely hard potable water. Shortening the heating intervals increases the service life.

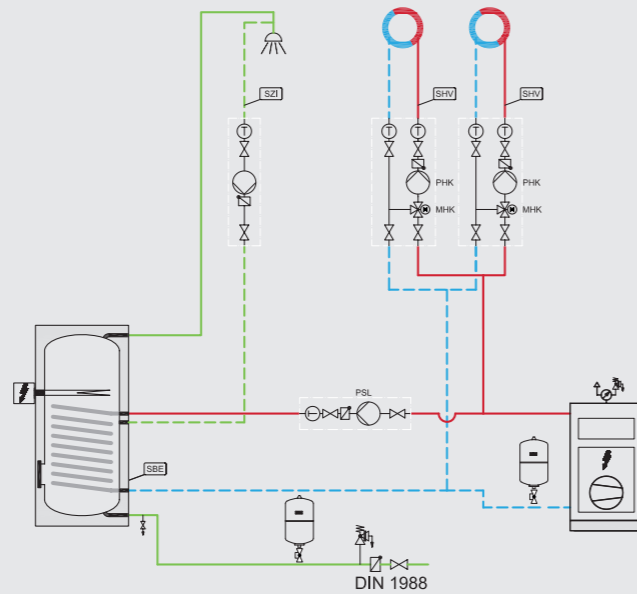

**Reflex Storatherm Aqua Compact**, installed below condensing boiler, circulation, 2 HK

Heating system with gas condensing boiler, two mixed heating circuits and internal boiler charging pump for hot water preparation in the upright Storatherm Aqua Compact with WW circulation.



**Circulation**

The actuation of the circulation pump for energy saving must be executed based on time and temperature. If a service water mixer is required as protection against scalding (solar/biomass), the circulation must be integrated so that the circulation return flow can bypass the tank.

**Condensing boilers with internal pumps and change-over valves**

It is essential to consult the manufacturer on integration of the condensing boiler. It is not possible to consider the different versions (one or two pumps in the flow / return flow, change-over valve in the flow / return flow, hydraulic separator) here.

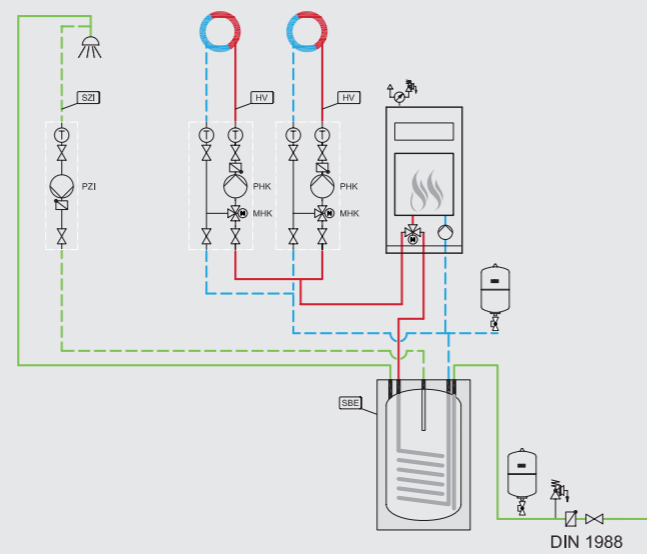

**Reflex Storatherm Aqua Compact, wall-hung**, condensing boiler, 2 HK

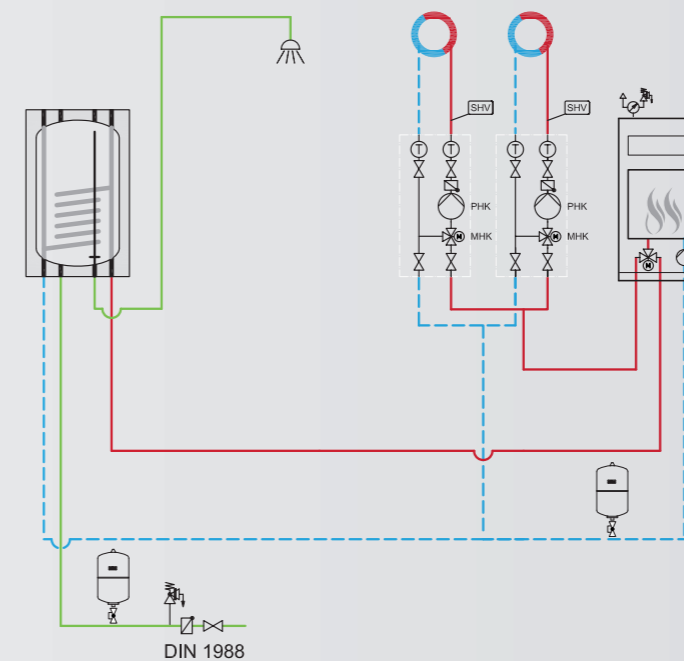

Heating system with gas condensing boiler, two mixed heating circuits and internal boiler charging pump for hot water preparation in the wall-hung Storatherm Aqua Compact. All connections shown at the bottom of the tank.

**Condensing boilers with internal pumps and change-over valves**

It is essential to consult the manufacturer on integration of the condensing boiler. It is not possible to consider the different versions (one or two pumps in the flow / return flow, change-over valve in the flow / return flow, hydraulic separator) here.

**Reflex Storatherm Aqua Load**, heat generator, charging station, circulation, electrical backup

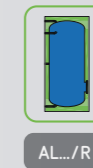
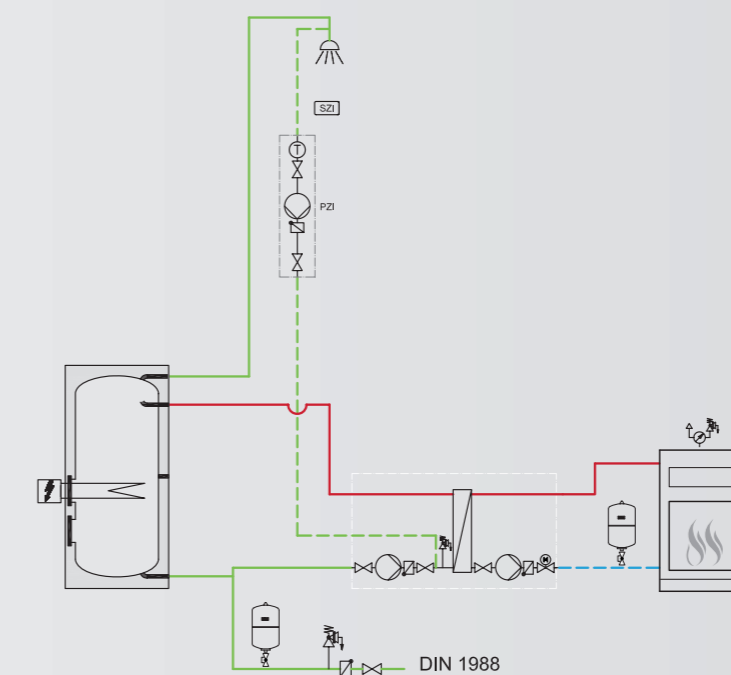

Charging the Storatherm Aqua Load using heat generator and external charging station. Integration of the circulation line in the charging station. Additional option of electrical auxiliary heating by means of built-in flange heater.

**Circulation**

The actuation of the circulation pump for energy saving must be executed based on time and temperature. If a service water mixer is required as protection against scalding (solar/biomass), the circulation must be integrated so that the circulation return flow can bypass the tank.

**Electric heating for potable water**

There is an increased risk of calcification in extremely hard potable water. Shortening the heating intervals increases the service life.

# Buffer storage tanks

## Key benefits

More comfort at home and efficiency thanks to complete separation of the generation and use of heat

- Efficient and low loss storage of surplus heat not used directly
- Many connections for optimum integration of the widest variety of heat sources
- Longer service life of the system by reducing the start-up cycles of the heating system

Extensive portfolio and accessories

- Additional maintenance opening and connections for further heat sources
- A solar-thermal system or with the right equipment even several additional heat generators can be included in the heating system via integrated heat exchangers, for example

The perfect add-on for various energy concepts

- Heat pump systems permit cost-effective operation of the heat pump, regardless of current heat demand
- The overabundance of energy from solar systems is stored and then available to you for longer, even in the absence of sunlight
- In the case of solid fuel boilers, continuous and efficient boiler operation can be ensured for slow-firing systems
- In the case of CHPs, the waste heat from the generation of electrical energy is stored and ready for release at peak heat loads
- And in the case of heating systems, for covering and safeguarding peaks in demand



More information is available on the official websites of Germany's Federal Ministry for Economic Affairs and Energy or Germany's Federal Office for Economic Affairs and Export Control: [www.bmwi.de](http://www.bmwi.de) [www.bafa.de](http://www.bafa.de)

## Design, function, application

Fossil fuels are becoming scarcer and energy costs rising continuously with each passing year. The realignment towards forward-looking energy production processes, such as combined heat and power generation or heat pumps, is one possible approach. The Reflex buffer storage tanks allow us to make a contribution to

the conservation of primary energy resources. The separation of energy supply and consumption permits the optimum operation of slow-firing boilers, for example, without having to accept any restrictions in use. Reflex buffer storage tanks also showcase their strength in connection with solar systems and CHPs.

### Design: Storatherm Heat

Reflex buffer storage tanks operate according to the stratified storage principle and act like a heating battery. A buffer storage tank can separate heat generation and consumption—both in terms of time and hydraulically. This makes optimum alignment of heat generation and heat consumption possible.

Three connections at the top for charging and discharging lines and two at the bottom for the return flow lines from the heat consumer (or to the heat generator) allow for a multitude of switching options and connection variants. This functional principle can also be applied to cold water systems, of course. However, a diffusion-tight insulation must be provided on-site in this case.

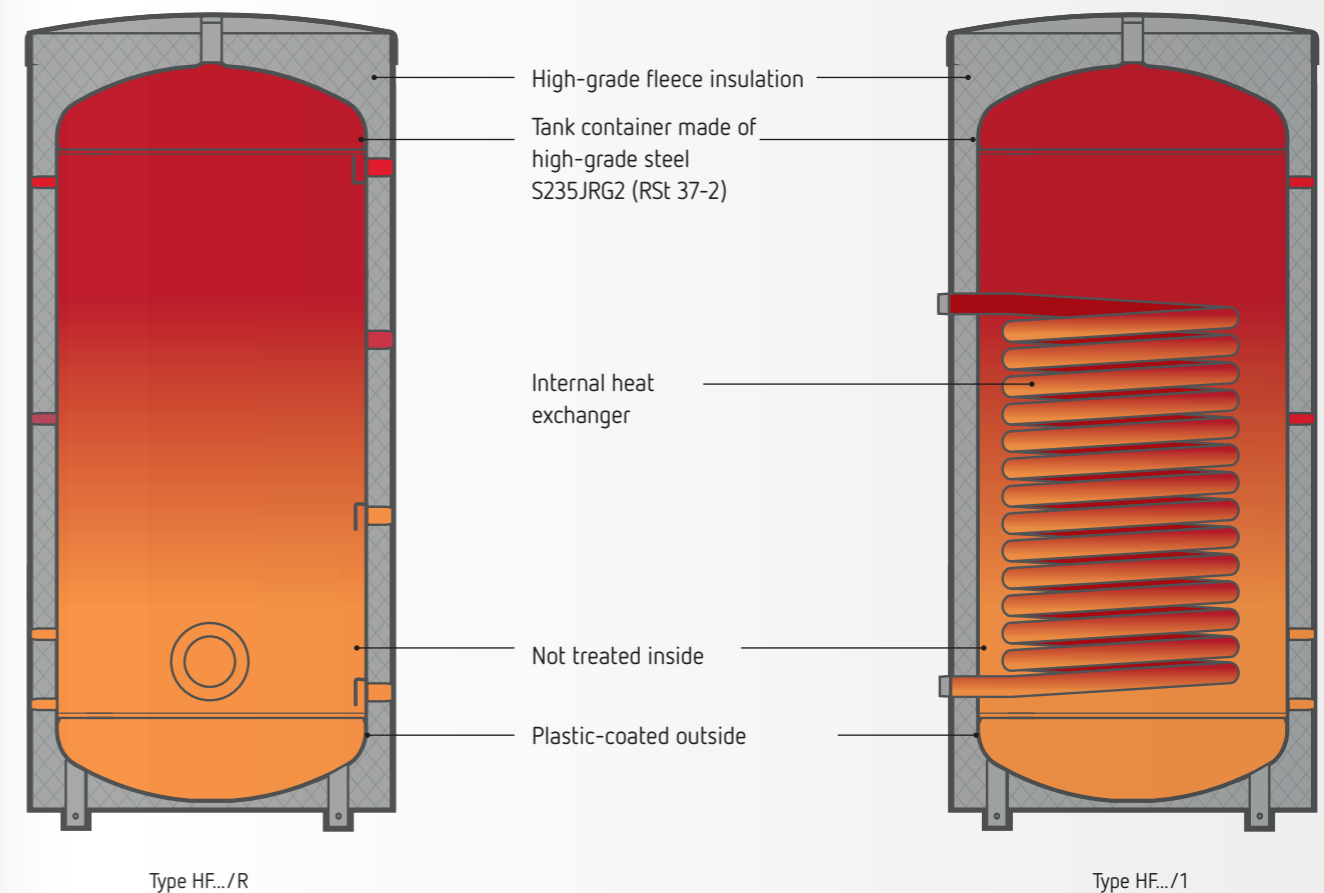

# Buffer storage tanks

## Storatherm Heat buffer storage tank for heating and cooling systems

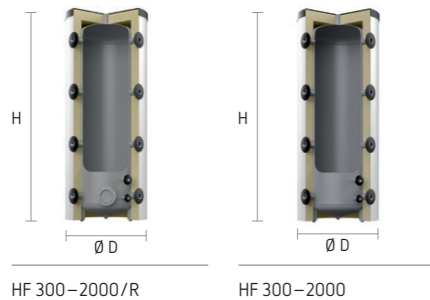

- Technical features**
- High-grade steel S235JRG2 (RSt 37-2) for heating and cooling applications
  - Tank not treated inside, plastic-coated outside
  - Maximum operating overpressure: tank 3 bar (or 6 bar from 1500)
  - Maximum operating temperature: tank 95 °C

### Type overview

<p><b>HF.../R</b> Buffer storage tank with cleaning aperture and insulation 300–2,000 l</p> <p><b>Insulation</b> Up to 1,000 litres: 100 mm fleece insulation with foil jacket, removable From 1,500 litres: 120 mm fleece insulation with foil jacket, removable</p>	<p><b>H.../R</b> Buffer storage tank with cleaning aperture <b>without insulation</b> for cooling applications. A suitable diffusion-tight heat insulation must be provided on-site. For sizes 3,000–5,000 litres, insulation for heating water applications is available separately. 300–5,000 l</p> <p><b>Without insulation</b></p>	<p><b>HF...</b> Buffer storage tank with insulation, without inspection flange 300–2,000 l</p> <p><b>Insulation</b> Up to 1,000 litres: 100 mm fleece insulation with foil jacket, removable From 1,500 litres: 120 mm fleece insulation with foil jacket, removable</p>
---	--	--

Type	Prod. no.		Content [l]	Ø D without/with ins. [mm]	Height H without ins. = with ins. [mm]	Sleeves 9x [inches"]	Tilted dimension [mm]	Standing losses W	EEC
	white	silver							
<b>Storatherm Heat HF.../R fleece insulation with foil jacket</b>									
HF 300/R_C	7842600	7842000	300	597/797	1,320	Rp 1 ½	1,355	79	C
HF 500/R_C	7842700	7842100	500	597/797	1,950	Rp 1 ½	1,975	106	C
HF 800/R_C	7842800	7842200	800	790/990	1,825	Rp 1 ½	1,870	132	C
HF 1000/R_C	7842900	7842300	1,000	790/990	2,115	Rp 1 ½	2,153	141	C
HF 1500/R_C	7843000	7842400	1,500	1,000/1,240	2,120	Rp 1 ½	2,178	167	C
HF 2000/R_C	7843100	7842500	2,000	1,200/1,440	2,122	Rp 1 ½	2,200	188	C
<b>Storatherm Heat HF... fleece insulation with foil jacket, without inspection flange</b>									
HF 300_C	-	7839100	300	597/797	1,320	Rp 1 ½	1,335	79	C
HF 500_C	-	7839200	500	597/797	1,950	Rp 1 ½	1,975	106	C
HF 800_C	-	7839300	800	790/990	1,825	Rp 1 ½	1,870	132	C
HF 1000_C	-	7839400	1,000	790/990	2,115	Rp 1 ½	2,153	141	C
HF 1500_C	-	7839500	1,500	1,000/1,240	2,120	Rp 1 ½	2,178	167	C
HF 2000_C	-	7839600	2,000	1,200/1,440	2,122	Rp 1 ½	2,200	188	C
<b>Storatherm Heat H.../R without heat insulation, coated grey</b>									
H 300/R	-	7783600	300	597/-	1,320	Rp 1 ½	1,355	-	-
H 500/R	-	7783800	500	597/-	1,950	Rp 1 ½	1,975	-	-
H 800/R	-	7784005	800	790/-	1,825	Rp 1 ½	1,870	-	-
H 1000/R	-	7784205	1,000	790/-	2,115	Rp 1 ½	2,153	-	-
H 1500/R	-	7784400	1,500	1,000/-	2,120	Rp 1 ½	2,178	-	-
H 2000/R	-	7784600	2,000	1,200/-	2,122	Rp 1 ½	2,200	-	-
H 3000/R	-	7788200	3,000	1,500/1,740	2,101	Rp 2	2,205	-	-
H 4000/R	-	7788500	4,000	1,500/1,740	2,676	Rp 2	2,756	-	-
H 5000/R	-	7788800	5,000	1,500/1,740	3,211	Rp 4	3,264	-	-

Type	Prod. no.	Colour
HW 3000/R	9125888	white
HW 4000/R	9125889	white
HW 5000/R	9125890	white

## Storatherm Heat buffer storage tank with heating coils for heating and cooling systems

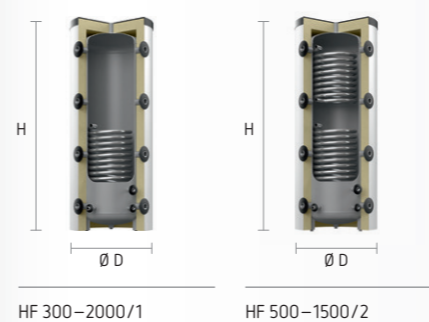

- Technical features**
- High-grade steel S235JRG2 (RSt 37-2) for heating and cooling applications
  - One or two heating coil(s) for connecting an additional heat source, e.g. a solar system
  - Tank not treated inside, plastic-coated outside
  - Maximum operating overpressure: tank 3 bar (from 1500, 6 bar), heating water 10 bar
  - Maximum operating temperature: tank 95 °C, heating water 110 °C

### Type overview

<p><b>HF.../1</b> Buffer storage tank with heating coil and insulation 300–2,000 l</p> <p><b>Insulation</b> Up to 1,000 litres: 100 mm fleece insulation with foil jacket, removable From 1,500 litres: 120 mm fleece insulation with foil jacket, removable</p>	<p><b>H.../1</b> Buffer storage tank with heating coil <b>without insulation</b> for cooling applications. A suitable diffusion-tight heat insulation must be provided on-site. For sizes 3,000–5,000 litres, insulation for heating water applications is available separately. 300–5,000 l</p> <p><b>Without insulation</b></p>	<p><b>HF.../2</b> Buffer storage tank with two heating coils and insulation 500–1,500 l</p> <p><b>Insulation</b> Up to 1,000 litres: 100 mm fleece insulation with foil jacket, removable From 1,500 litres: 120 mm fleece insulation with foil jacket, removable</p>
--	---	---

Type	Prod. no.		Content [l]	Ø D <sup>1)</sup> without/with ins. [mm]	Height H without ins. = with ins. [mm]	Sleeves 9x [inches"]	Tilted dimension [mm]	Standing losses W	EEC
	white	silver							
<b>Storatherm Heat HF.../1 fleece insulation with foil jacket</b>									
HF 300/1_C	7843800	7843200	300	597/797	1,320	Rp 1 ½	1,355	79	C
HF 500/1_C	7843900	7843300	500	597/797	1,950	Rp 1 ½	1,975	106	C
HF 800/1_C	7844000	7843400	800	790/990	1,825	Rp 1 ½	1,870	132	C
HF 1000/1_C	7844100	7843500	1,000	790/990	2,115	Rp 1 ½	2,153	141	C
HF 1500/1_C	7844200	7843600	1,500	1,000/1,240	2,120	Rp 1 ½	2,178	167	C
HF 2000/1_C	7844300	7843700	2,000	1,200/1,440	2,122	Rp 1 ½	2,200	188	C
<b>Storatherm Heat HF.../2 fleece insulation with foil jacket, without inspection flange</b>									
HF 500/2_C	-	7837100	500	597/797	1,950	Rp 1 ½	1,975	106	C
HF 800/2_C	-	7837200	800	790/990	1,825	Rp 1 ½	1,870	132	C
HF 1000/2_C	-	7837300	1,000	790/990	2,115	Rp 1 ½	2,153	141	C
HF 1500/2_C	-	7837400	1,500	1,000/1,240	2,120	Rp 1 ½	2,178	167	C
<b>Storatherm Heat H.../1 without heat insulation</b>									
H 300/1	7783700	-	300	597/-	1,320	Rp 1 ½	1,355	-	-
H 500/1	7783900	-	500	597/-	1,950	Rp 1 ½	1,975	-	-
H 800/1	7784115	-	800	790/-	1,825	Rp 1 ½	1,870	-	-
H 1000/1	7784315	-	1,000	790/-	2,115	Rp 1 ½	2,153	-	-
H 1500/1	7784500	-	1,500	1,000/-	2,120	Rp 1 ½	2,178	-	-
H 2000/1	7784700	-	2,000	1,200/-	2,122	Rp 1 ½	2,200	-	-
H 3000/1	7788300	-	3,000	1,500/1,740	2,101	Rp 2	2,205	-	-
H 4000/1	7788600	-	4,000	1,500/1,740	2,676	Rp 3	2,756	-	-
H 5000/1	7788900	-	5,000	1,500/1,740	3,211	Rp 4	3,264	-	-

Type	Prod. no.	Colour
HW 3000/1	9125988	white
HW 4000/1	9125989	white
HW 5000/1	9125990	white

Geometric data: Storatherm Heat

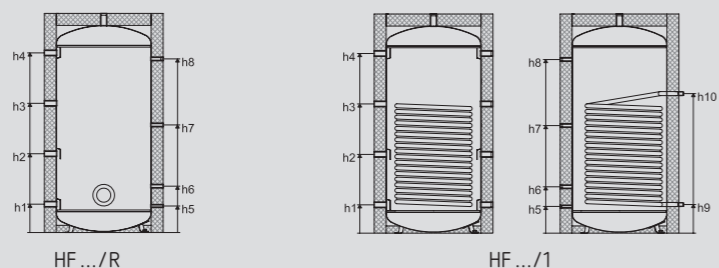

Type		HF 300/R HF 300/1	HF 500/R HF 500/1	HF 800/R HF 800/1	HF 1000/R HF 1000/1	HF 1500/R HF 1500/1	HF 2000/R HF 2000/1	HF 3000/R HF 3000/1	HF 4000/R HF 4000/1	HF 5000/R HF 5000/1
Weight	HF.../R	kg	62	75	127	142	189	269	-	-
	H.../R	kg	58	71	121	135	181	257	570	677
	HF.../1	kg	82	100	197	225	272	352	-	-
	H.../1	kg	74	95	190	216	265	341	637	754
Connection, heating source	h1	Rp	1 1/2	1 1/2	1 1/2	1 1/2	1 1/2	1 1/2	2	2
		mm	225	225	236	310	341	365	495	496
Connection, heating source	h2	Rp	1 1/2	1 1/2	1 1/2	1 1/2	1 1/2	1 1/2	2	2
		mm	490	701	656	768	798	805	845	1,090
Connection, heating source	h3	Rp	1 1/2	1 1/2	1 1/2	1 1/2	1 1/2	1 1/2	2	2
		mm	760	1,181	1,076	1,228	1,258	1,245	1,247	1,577
Connection, heating source	h4	Rp	1 1/2	1 1/2	1 1/2	1 1/2	1 1/2	1 1/2	2	2
		mm	1,033	1,655	1,496	1,681	1,716	1,680	1,597	2,171
Connection, sensor	h5	Rp	1/2	1/2	1/2	1/2	1/2	1/2	1/2	1/2
		mm	210	210	221	296	341	365	495	496
Connection, sensor	h6	Rp	3/4	3/4	3/4	3/4	3/4	3/4	3/4	3/4
		mm	380	375	386	461	551	575	845	1,090
Connection, sensor	h7	Rp	3/4	3/4	3/4	3/4	3/4	3/4	3/4	3/4
		mm	670	945	896	1,011	1,096	1,100	1,247	1,577
Connection, sensor	h8	Rp	3/4	3/4	3/4	3/4	3/4	3/4	3/4	3/4
		mm	960	1,515	1,446	1,581	1,556	1,630	1,597	2,171
Connection, solar flow HF.../1 and H.../1	h9	Rp	1	1	1	1	1 1/4	1 1/4	1 1/4	1 1/4
		mm	710	955	1,160	1,322	1,367	1,393	1,095	1,216
Connection, solar return flow HF.../1 and H.../1	h10	Rp	1	1	1	1	1 1/4	1 1/4	1 1/4	1 1/4
		mm	210	210	236	296	341	367	495	496
Connection, solar flow (bottom) HF.../2 and H.../2	h9	Rp	-	1	1	1	1 1/4	1 1/4	-	-
		mm	-	-	955	776	956	1,093	1,120	-
Connection, solar return flow (bottom) HF.../2 and H.../2	h10	Rp	-	1	1	1	1 1/4	1 1/4	-	-
		mm	-	210	236	296	341	367	-	-
Connection, solar flow (top) HF.../2 and H.../2	h11	Rp	-	1	1	1	1 1/4	1 1/4	-	-
		mm	-	1,660	1,483	1,776	1,707	1,665	-	-
Connection, solar return flow (top) HF.../2 and H.../2	h12	Rp	-	1	1	1	1 1/4	1 1/4	-	-
		mm	-	1,181	1,123	1,248	1,228	1,255	-	-
Heating surface	H.../1	m <sup>2</sup>	1.34	1.88	3.76	4.48	4.48	4.48	5.00	6.00
	H.../2 bottom	m <sup>2</sup>	-	1.88	2.47	3.10	3.72	3.72	-	-
	H.../2 top	m <sup>2</sup>	-	1.17	1.36	2.47	2.37	2.05	-	-
Insulation thickness		mm	100	100	100	100	120	120	120	120

Subject to technical modifications | EEHR = electro screw-in heater, EFHR = electro flange heater

Storatherm Heat Combi combination storage tank with heating coils

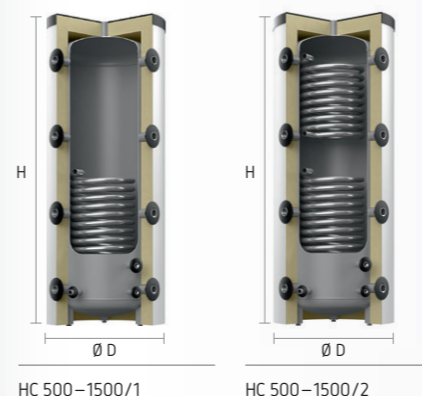

- Technical features**
- For hot water preparation and backup heating
  - Potable water heating according to the continuous flow principle (corrugated stainless steel pipe)
  - Tank not treated inside, plastic-coated outside
  - Maximum operating overpressure: tank 3 bar | heating water 10 bar | potable water 6 bar
  - Maximum operating temperature: tank 95 °C | heating water 110 °C | potable water 95 °C

Type overview

**HC.../1**  
Combination storage tank with one heating coil and a corrugated stainless steel pipe for heating potable water according to the continuous flow principle

**Insulation**  
120 mm fleece insulation with foil jacket, removable

**HC.../2**  
Combination storage tank with two heating coils and one corrugated stainless steel pipe for heating potable water according to the continuous flow principle

**Insulation**  
120 mm fleece insulation with foil jacket, removable

Type	Prod. no.	Content [l]	Ø D without/with ins. [mm]	Height H without ins. = with ins. [mm]	Sleeves 9x [inches"]	Tilted dimension [mm]	Output capacity <sup>1)</sup> [l]	Standing losses W	EEC
Storatherm Heat Combi HC.../1 combination storage tank with one additional heating coil									
HC 500/1_C	7859200	428	600/840	1,970	Rp 1 1/2	1,974	299	106	C
HC 800/1_C	7859300	722	790/1,030	1,850	Rp 1 1/2	1,870	409	132	C
HC 1000/1_C	7859400	852	790/1,030	2,140	Rp 1 1/2	2,153	495	141	C
HC 1500/1_C	7859500	1,332	1,000/1,240	2,130	Rp 1 1/2	2,178	737	167	C
Storatherm Heat Combi HC.../2 combination storage tank with two additional heating coils									
HC 500/2_C	7859600	418	600/840	1,970	Rp 1 1/2	1,974	299	106	C
HC 800/2_C	7859700	706	790/1,030	1,850	Rp 1 1/2	1,870	409	132	C
HC 1000/2_C	7859800	833	790/1,030	2,140	Rp 1 1/2	2,153	495	141	C
HC 1500/2_C	7859900	1,317	1,000/1,240	2,130	Rp 1 1/2	2,178	737	167	C

<sup>1)</sup> t<sub>KW</sub> = 10 °C, t<sub>WW</sub> = 45 °C, t<sub>buffer</sub> = 65 °C, draw-off = 10 l/min





# Selection and calculation

## Dimensioning buffer storage tanks

### General information

Buffer storage tanks separate the consumption and supply of heat. They store hot water from the time it is heated until it is drawn off. This means that heat generation and consumption can be optimised largely independently of each other in terms of time and hydraulically.

#### Principles of dimensioning

Buffer storage tanks are selected and designed according to the

- type of heat generation (e.g. furnace, solar collectors, CHP)
- type of consuming system (e.g. underfloor heating, radiator or potable water storage tank)
- specific heat requirement (i.e. the usable heat quantity)
- charging and discharging capacities and charging and discharging times
- characteristics of the heat-transfer media (e.g. treated water)
- characteristics of the heat-transfer components (e.g. pipelines, etc.)
- hydraulic aspects (e.g. pressure conditions)

In certain residential buildings, single buffer storage tanks with a capacity of up to 1,000 litres are often used. In larger systems, several buffer storage tanks

connected in parallel or series are often used to optimise heat stratification and due to building specifications.

#### Buffer storage tank characteristics

Concurrent selection criteria:

- Tank size (capacity) in l
- Usable heat quantity in kJ or kWh
- Utilisation ratio
- Dimensions and connections
- Auxiliary heating, e.g. electric heating element

### Sample schematic

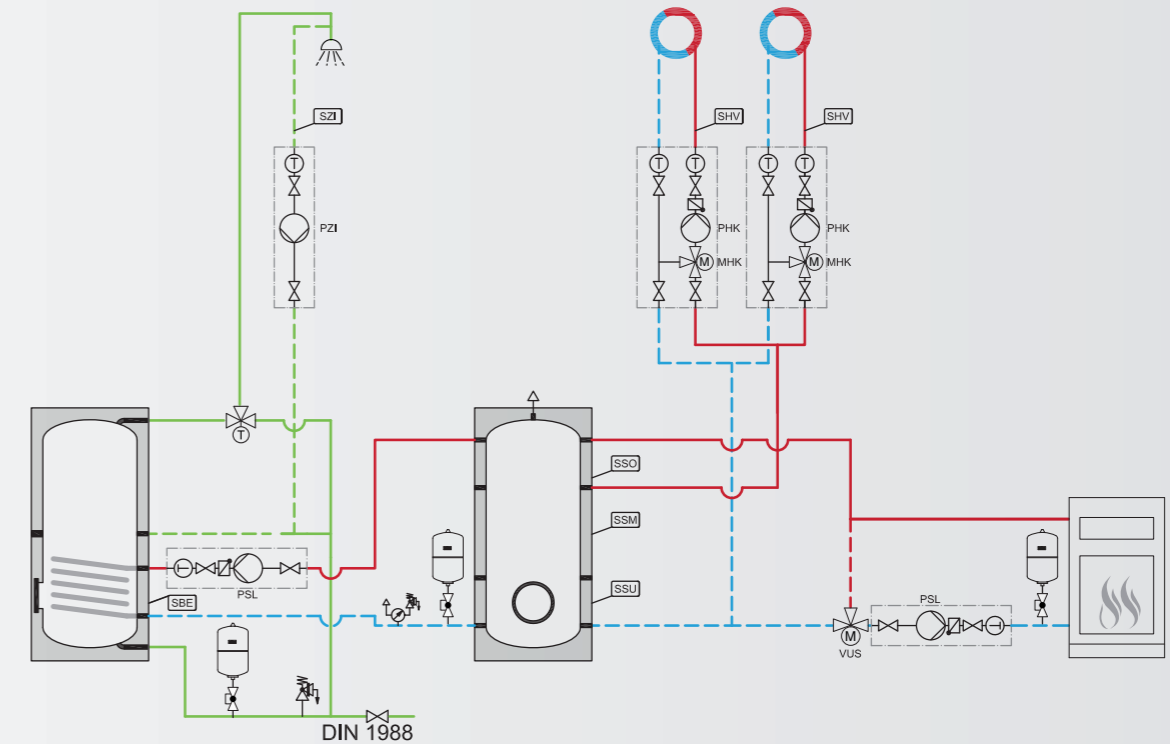

Reflex Storatherm Heat, biomass boiler, Storatherm Aqua, circulation, 2 HK

### Quick selection of heating tanks

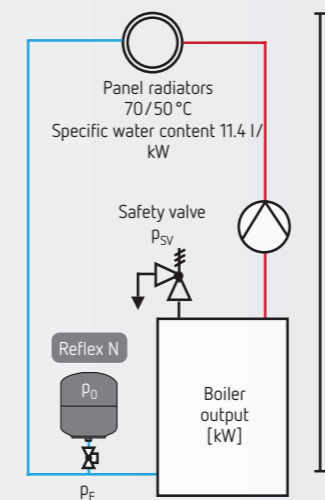

Static pressure  $p_{stat} = \text{static elevation [m]} / 10$   
 Inlet pressure  $p_0 = p_{stat} + 0.2 \text{ bar}$   
 Filling pressure  $p_F = p_0 + 0.3 \text{ bar (for cold system)}$

Reflex N	Safety valve 2.5 bar		Safety valve 3.0 bar	
	Inlet pressure [bar]		Inlet pressure [bar]	
Output [kW]	1.0	1.5	1.0	1.5
10	N 18	N 35	N 18	N 25
20	N 35	N 80	N 25	N 35
30	N 35	N 80	N 35	N 50
40	N 50	N 100	N 35	N 50
50	N 80	N 140	N 50	N 80
60	N 80	N 140	N 50	N 80
70	N 80	N 200	N 80	N 80
80	N 100	N 200	N 80	N 100
90	N 100	N 200	N 80	N 140
100	N 140	N 250	N 80	N 140
120	N 140	N 250	N 100	N 140
140	N 200	N 300	N 140	N 200
160	N 200	N 400	N 140	N 200
180	N 200	N 400	N 200	N 250
200	N 250	N 500	N 200	N 250

## Dimensioning buffer storage tanks in practise

### Individual calculation

We recommend an individual calculation based on empirical values when you dimension buffer storage tanks. This involves the consideration of various factors, such as approximate values for different sizes and the conversion of units.

**For your information** For a given boiler output or if the heat demand is known, you can roughly calculate the recommended tank volume as follows:

#### Solid fuels



The filling chamber volume in the boiler limits the amount of energy (kWh) for charging the buffer storage tank. The amount of energy can be calculated from the boiler output (kW) and the combustion time.

In the case of a wood heating system with an output of more than 15 kW, a buffer storage tank is mandatory under Germany's 1st Federal Emissions Protection Regulation.

#### Advice:

When calculating the amount of energy, the heat must be fully available for charging the buffer storage tank during combustion. In systems with an extremely long combustion time per filling, part of the heat is usually used for heating the building during combustion, meaning it is no longer available to charge the tank. Accordingly, a tank with lesser dimensions can be used.

#### Solar systems



#### Heat pumps



Buffer storage tanks must bridge interruptions in heat pump operation if heat is required during such periods. Design the tanks so that frequent starts for tank charging are avoided.

#### CHP



The aim is to extend runtimes and shift CHP operation to periods of increased power consumption. In the absence of other criteria and specifications for the dimensioning of the buffer storage tank, the tank should be able to buffer for at least one hour's module runtime under full load.

#### Advice:

Take into account the content of the buffer storage tank when dimensioning the expansion vessel. Buffer storage tanks can be dispensed with in CHP systems which only supply up to 20% of the heat required by the building.

Care must be taken when dimensioning the expansion vessel. For stratified charging of tanks connected in parallel, the volume flows must be carefully adjusted and balanced.



$$V_{sp} = 50 - 100 \text{ l / kW} \cdot \dot{Q}_k$$

$V_{sp}$  Volume of the buffer storage tank in l  
 $\dot{Q}_k$  Nominal boiler output or heat requirement in kW  
 50 – 100 l/kW Empirical value for the recommended tank volume per kilowatt of nominal boiler output

$$V_{sp} = 13.5 \cdot \dot{Q}_k \cdot T_B$$

Minimum tank size according to DIN EN 303-5:

$$V_{sp} = 15 \cdot \dot{Q}_k \cdot T_B \cdot (1 - 0.3 \cdot \dot{Q}_H / \dot{Q}_{Kmin})$$

$V_{sp}$  Volume of the buffer storage tank in l  
 $\dot{Q}_k$  Nominal boiler output in kW  
 $\dot{Q}_{Kmin}$  Lowest adjustable boiler output in kW  
 $T_B$  Nominal combustion period in h  
 $\dot{Q}_H$  Heating load of the building in kW

$$V_{sp} = A_{WF} \cdot v_{sp} / a_{wf}$$

$V_{sp}$  Volume of the buffer storage tank in l  
 $A_{WF}$  Living space to be heated in m<sup>2</sup>  
 $v_{sp}$  Specific tank volume per m<sup>2</sup> of collector surface in l/m<sup>2</sup> (recommended: 60 – 80 l/m<sup>2</sup>)  
 $a_{wf}$  Specific living space per m<sup>2</sup> of collector surface in m<sup>2</sup>/m<sup>2</sup> (recommended: 10 – 20 m<sup>2</sup>/m<sup>2</sup>)

$$V_{sp} = P_{WP} \cdot t / (c \cdot \Delta T)$$

$V_{sp}$  Volume of the buffer storage tank in l  
 $P_{WP}$  Heat output, heat pump in kW  
 $t$  Max. backup time for interruptions in operation  
 $c$  Specific heat capacity of water (c = 4.19 kJ/(kg · K))  
 $\Delta T$  Flow/Return flow temperature difference in K

$$V_{sp} = \dot{Q}_{CHP} \cdot c / \Delta T$$

$V_{sp}$  Volume of the buffer storage tank in l per h  
 $\dot{Q}_{CHP}$  Maximum output of CHP at nominal load  
 $c$  Specific heat capacity of water (c = 4.19 kJ/(kg · K))  
 $\Delta T$  Temperature spread of CHP in K, e.g. 20 K

# Typical installations

## Reflex Storatherm Heat biomass boiler, Storatherm Aqua, circulation, 2 HK

Heating system with biomass boiler and energy buffering in the Storatherm Heat. This supplies the two mixed heating circuits and the Storatherm Aqua for hot water preparation using a separate boiler charging pump. Incl. circulation and service water mixer to protect against scalding.

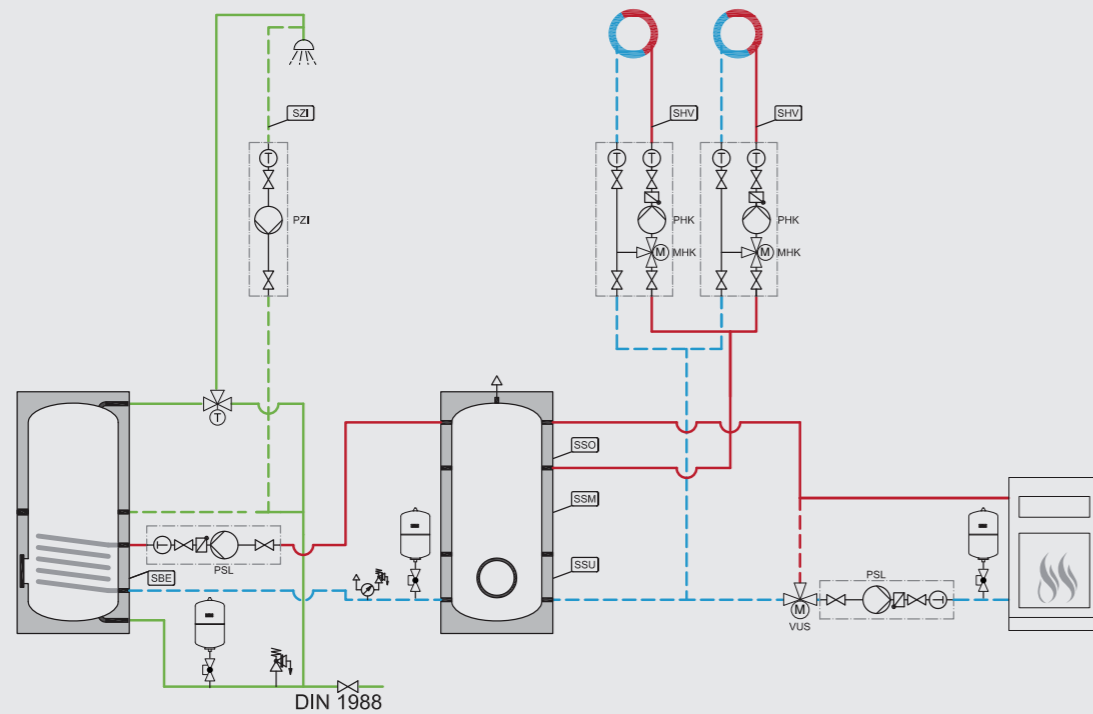

### Circulation

The actuation of the circulation pump for energy saving must be executed based on time and temperature. If a service water mixer is required as protection against scalding (solar/biomass), the circulation must be integrated so that the circulation return flow can bypass the tank.

### Biomass boilers—pellets and firewood

Depending on the manufacturer, a return flow temperature boost is necessary for the biomass boiler to prevent soot deposits in the heat generator. As a rule, all the energy generated is charged into the tank, where it is available for heating water and other heating purposes.

### Heat generator integration by means of buffering

All the energy generated is charged into the buffer storage tank, where it is available to the heating circuits and for potable water preparation. Accordingly, the heat generator does not switch as often. The buffer storage tank is usually divided into zones for potable water, heating and solar by means of hydraulic systems and controllers.

### Quality of heating water

In general (when using buffer storage tanks, in particular), the need to reprocess heating water in accordance with VDI 2035 must be established.

## Reflex Storatherm Heat Combi biomass boiler, solar system, circulation, 2 HK, electrical backup

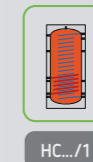

Solar heating system with biomass boiler and energy buffering in the Storatherm Heat Combi. This supplies the two mixed heating circuits and the hot water preparation. The solar system heats the combination storage tank via the internal heat exchanger. Incl. circulation and service water mixer to protect against scalding. As a backup solution, the electro screw-in heater can be used for water heating.

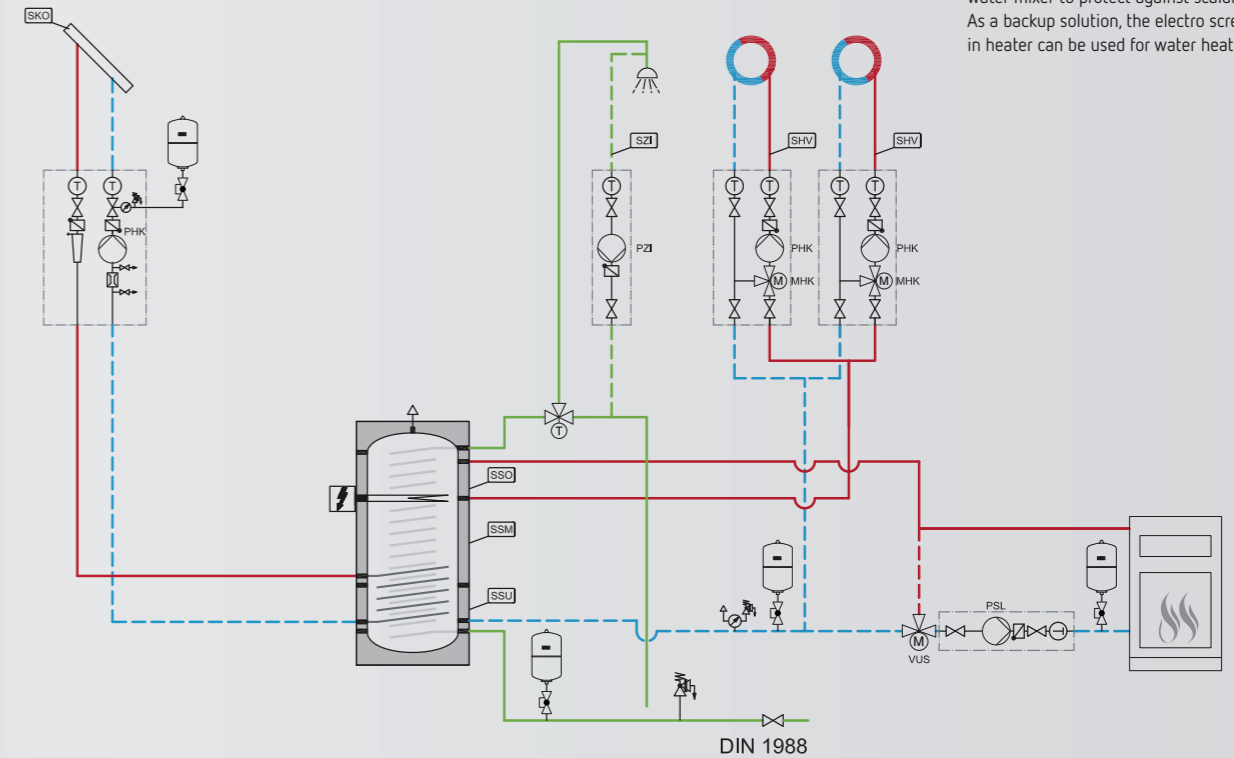

### Circulation

The actuation of the circulation pump for energy saving must be executed based on time and temperature. If a service water mixer is required as protection against scalding (solar/biomass), the circulation must be integrated so that the circulation return flow can bypass the tank.

### Biomass boilers—pellets and firewood

Depending on the manufacturer, a return flow temperature boost is necessary for the biomass boiler to prevent soot deposits in the heat generator. As a rule, all the energy generated is charged into the tank, where it is available for heating water and other heating purposes.

### Heat generator integration by means of buffering

All the energy generated is charged into the buffer storage tank, where it is available to the heating circuits and for potable

water preparation. Accordingly, the heat generator does not switch as often. The buffer storage tank is usually divided into zones for potable water, heating and solar by means of hydraulic systems and controllers.

### Solar pump controller

If the temperature in the collector exceeds the temperature in the tank, then the solar system controller switches on the pump. Depending on the type of controller, it can control the speed and thus volume flow in the solar circuit at a temperature difference or operate in on/off mode.

### Quality of heating water

In general (when using buffer storage tanks, in particular), the need to reprocess heating water in accordance with VDI 2035 must be established.

# Customised designs



In addition to our standard portfolio, we can also manufacture buffer storage tanks and catch tanks to customer specifications and in larger sizes. Our strength is supporting extensive major projects and systems with high output, high pressure and high water temperatures. Tanks with a capacity of up to 200,000 litres are offered. Every system is different. That is why the specific requirements of the customer are always the starting point of our thought process. We provide expert and bespoke advice

during the project planning phase across commissioning right through to documentation and maintenance. We have years of experience working in all relevant sectors and all types of buildings. Power stations, heating plants, hospitals, hotels, residential complexes, factories, data centres—we are in action wherever water-bearing building engineering solutions have to function with high reliability in sensitive surroundings.

## This is what we can offer you

- Higher volumes
- Lower or higher operating temperatures
- Stainless steel models
- Special accessories

## Selected references



### Winkelmann Powertrain Components GmbH + Co. KG

**Product**

3x Reflex buffer storage tanks (each with a capacity of 44,000 litres)

**Customer-specific requirement**

High tank volume

**Objective achieved**

Self-powered production of Winkelmann powertrain components since 1 January 2019. Current peaks can be balanced out as appropriate thanks to the buffer storage tank. They separate the generation and consumption of heat both in terms of time and hydraulically.

## Your benefits

- Years of experience in developing special solutions (power plants, district heating facilities, geothermal energy, etc.)
- DIN EN 12953 and TRD 604 certification for hot water systems
- International team with local knowledge
- Highest quality standards
- Audited processes
- Broad field of activity (virtually no constraints in respect of facility size, pressures, temperatures, make)
- Specialised in special solutions of any kind
- Consideration of international standards such as ASME, ANSI, etc.

# Accessories

Electric heating elements for the use of solar power for hot water preparation see pages 12-15



## Reflex EEHR electro screw-in heater 1 1/2"



EEHR 2.0 – 9.0 kW

Technical features

- Electrical auxiliary heating
- Suitable for the following types:
  - Storatherm Aqua Heat Pump
  - Storatherm Aqua Solar
  - Storatherm Aqua
  - Storatherm Heat Combi
- Additional seal and flange cover required for flanged installation
- Safety temperature limiter (STB) 98 °C
- Control light to indicate operation mode
- Degree of protection: IP 45
- Electrical connection (on-site)
- Not approved for continuous operation
- Water hardness: max. 14°dH

Type	Prod. no.	Tank size [l]	Output [kW]	Voltage [V]	Installation length L [mm]
EEHR 2.0	9126474	> 100	2.0	230	320
EEHR 2.5	9126475	> 100	2.5	230	390
EEHR 3.0	9126476	> 100	3.0	230	390
EEHR 3.8	9126477	> 100	3.8	400	430
EEHR 4.5	9126478	> 300	4.5	400	470
EEHR 6.0	9126479	> 300	6.0	400	500
EEHR 7.5	9126480	> 750	7.5	400	720
EEHR 9.0	9126481	> 1,000	9.0	400	780

Accessories are selected based on tank volume according to the table



Reflex flange cover with 1 1/2" sleeve			
Type	Prod. no.	Tank size [l]	Ø D [mm]
Flange cover with 1 1/2" sleeve			
Bolt circle: 150 mm	7760000	150 – 500	150
Bolt circle: 225 mm	7760100	750 – 3,000	225
Flange seal			
Bolt circle: 150 mm	7760900	150 – 500	150
Bolt circle: 225 mm	7761000	750 – 3,000	225

- For optional assembly of a 1 1/2" EEHR electro screw-in heater
- Hole flange replaces standard blind flange at the tank's maintenance opening
- Seal ordered separately

## Reflex EFHR electro flange heater

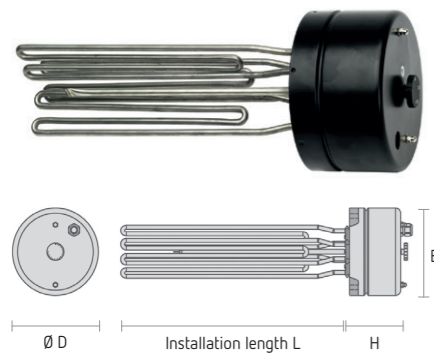

EEHR 4.0–35.0 kW

Technical features

- Electrical auxiliary heating
- Approved for continuous operation
- Suitable for the types:
  - Storatherm Aqua Heat Pump
  - Storatherm Aqua Solar
  - Storatherm Aqua
  - Storatherm Aqua Load
  - Storatherm Heat HF...R
- Easy integration via the tank's maintenance opening
- Up to 10.0 kW LK 150 mm → ≤ 500-litre tank volume
- From 16.0 kW LK 225 mm → > 500-litre tank volume
- Three power levels, switchable
- Temperature controller up to 95 °C
- Safety temperature limiter 120 °C
- Electrical connection (on-site)
- Incl. flange and seal

Type	Prod. no.	Buffer storage tank size [l]	Potable water tank size [l]	Output [kW]	Voltage [V]	Installation length L [mm]	Breadth B [mm]	Height H [mm]	Ø D [mm]
EFHR 4.0	9116314	300–5,000	150–150	4.0/2.7/2.0	400	295	150	110	185
EFHR 6.0	9116315	300–5,000	300–500	6.0/4.0/3.0	400	395	150	110	185
EFHR 8.0	9116316	300–5,000	300–500	8.0/5.5/4.0	400	495	150	110	185
EFHR 10.0	9116317	300–5,000	300–500	10.0/6.7/5.0	400	495	150	110	185
EFHR 16.0	9116501	not suitable	> 750	16.0/11.0/8.0	400	610	225	140	280
EFHR 19.0	9116502	not suitable	> 1,000	19.0/12.7/9.0	400	740	225	140	280
EFHR 25.0	9115569	not suitable	> 1,000	25.0/18.8/12.5	400	740	225	140	280
EFHR 35.0	9126720	not suitable	> 1,500	35.0/26.4/17.5	400	900	225	140	280

NEW!

## Fleece insulation with foil jacket/assembly on-site

Type	Prod. no.	Colour
HW 3000	9125888	White
HW 4000	9125889	White
HW 5000	9125890	White

## Reflex RWT finned heat exchanger

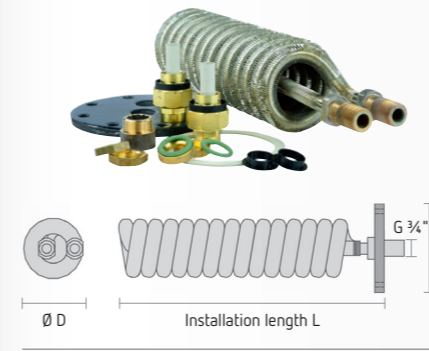

Reflex RWT

Technical features

- For integration of an additional heat generator, e.g. solar system
- Suitable for the following models:
  - Storatherm Aqua Heat Pump
  - Storatherm Aqua Solar
  - Storatherm Aqua
  - Storatherm Aqua Load
  - Storatherm Heat
- Incl. counterflange and seal
- RWT 1: LK 150 mm = potable water storage tank ≤ 500 litres and all buffer storage tanks
- RWT 2: LK 225 mm = potable water storage tank ≥ 750 litres
- Approved for heating water, solar fluid
- Made using copper finned tube
- Electrically insulated connections for galvanic isolation
- Max. operating overpressure: 10 bar; max. operating temperature: 90 °C

Type	Prod. no.	Output <sup>1)</sup> [kW]	Surface [m <sup>2</sup> ]	Installation length L [mm]	Breadth B [mm]	Ø D [mm]
RWT 1	7755900	9 – 11	1.1	420	150	110
RWT 2	7756300	31 – 39	2.3	540	225	170

<sup>1)</sup> Output for HW-VL 70–80 °C with 0.65 m<sup>3</sup>/h; TW from 10 °C to 45 °C

## Impressed-current anodes



Impressed-current anode

Technical features

- Maintenance-free continuous protection according to DIN 4753-3 and 4753-6
- Voltage-controlled power supply 230 V; 50/60 Hz
- Wear-free titanium electrode
- Protection Class II (operation in closed rooms)
- Reducer G 1" – G 3/4" (on-site)

Type	Prod. no.	Advice
Impressed-current anode, G 3/4" x 400 mm, 230 V	7751300	Not for AC 120/1, reducer G 1" – G 3/4" (on-site)
Impressed-current anode, G 1 1/4" x 800 mm	9119365	For AF 1500/1, AF 1500/2, AF 2000/1, AF 2000/2

## Spare parts

### Magnesium protective anodes



Magnesium rod anode

Technical  
features

- For cathodic protection against corrosion
- All Reflex storage water heaters have factory-fitted magnesium rod anodes
- From type AF 750/1; AF 750/2; AL 1500/R2; AH 750/1, and AH 750/2 with two anodes

Type	Prod. no.	Advice	Type of tank
Magnesium protective anode	7751580	G 1 x 26 x 400	AF/AB 100/1
Magnesium protective anode	7757400	M 8 x 26 x 420	AC 120/1
Magnesium protective anode	7751400	G 1 x 26 x 480	AC 150/1; AF/AB 150/1
Magnesium protective anode	7751500	G 1 x 26 x 550	AF/AB 200/1, AF/AB 200/2, AC .../200
Magnesium protective anode	7751510	G 1 x 26 x 800	AL 300/R; AF/AB 300/1, AF/AB 300/2 Ø 700
Magnesium protective anode	7751520	G 1 x 26 x 900	AL 300/R - AL 500/R; AF/AB 400/1, AF/AB 300/1 Ø 600; AF/AB 400/2
Magnesium protective anode	7751530	G 1 x 26 x 1,100	AL 500/R; AF/AB 500/1, AF/AB 500/2
Magnesium protective anode	7751540	G 1¼ x 33 x 530; 2 pieces required	AF 750; AL 1500–3000 litres
Magnesium protective anode	7751610	G 1¼ x 33 x 625; 2 pieces required	AH 300/1; AH 300/2; AF 1000/1 (2 pcs. required)
Magnesium protective anode	7751570	G 1¼ x 33 x 1,060	AH 400/1; AH 400/2; AF 750/2; AH 750/1; AH 750/2
Magnesium protective anode	7751590	G 1¼ x 33 x 1,250	AH 500/1; AH 500/2, AF 1000/2; AH 1000/1; AH 1000/2
Magnesium protective anode	7751560	G ¾ x 22 x 790	AC 250/1
Magnesium protective anode	7751620	G 1¼ x 33 x 590	AL 750/R; AH 750/1; AH 750/2; AH 1000/1; AH 1000/2
Magnesium protective anode	7751630	G 1¼ x 33 x 690	AL 1000/R2

#### Chain anodes

Type	Prod. no.	Advice
Chain anode, G1 x 22 x 1600 mm	7751600	Not for AC 120/1; AC 150/1; AC 250/1; AF 750/1 – AF 3000/1; AL 750/R – AL 3000/R2; AH 750/1; AH 1000/1; AH 750/2; AH 1000/2

- For retrofitting in case of low ceiling heights

### Other spare parts

Type	Prod. no.
<b>Spare parts for electro flange heaters EFHR</b>	
Flange seal LK 150 (flat seal)	7761020
Flange seal LK 225 (flat seal)	7761030
Control thermostat	9200447
<b>Spare parts for electro screw-in heaters EEHR</b>	
Seal 1 ½"	9119368
Flange cover LK 150, enamelled with sleeve Rp 1 ½"	7760000
Flange seal LK 150 (profile seal) for flange cover with sleeve	7760900
Flange cover LK 225, enamelled with sleeve Rp 1 ½"	7760100
Flange seal LK 225 (profile seal) for flange cover with sleeve	7761000
Control thermostat (green housing)	9200445
<b>Spare parts for RWT</b>	
Flange cover LK 150, enamelled, two holes for RWT 1	7759950
Flange seal LK 150 (flat seal)	7761020
Flange cover LK 225, enamelled, two holes for RWT 2	7759960
Flange seal LK 225 (flat seal)	7761030
<b>Miscellaneous</b>	
Flange seal LK 150 (profile seal) for flange cover with sleeve	7760900
Control thermostat for tank charging pump	7751100

# Reflex solutions

**Solution No 02 Potable water storage tanks in solar applications**

A solar system (supported by heat generator if required) is used for heating potable water.

For solar applications, special components like the Exvoid T Solar for displacement venting or the Reflex S solar vessel must be integrated.

To comply with VDI 2035, Fillsoft is used with a softening or demineralisation cartridge (depending on water quality or specifications of the boiler's manufacturer).

**Buffer storage tank in a heating system**

**Solution No 07**

An additional hydraulic separator is required if an excessive pressure loss in the supply line to the manifold necessitates another pump. The low loss header allows the tank to discharge as required.

**Solution No 09 Potable water storage tanks with legionella prophylaxis, LegioNixx**

Dead zones without structural alternations are avoided and the development of legionellae prevented by using the potable water manifold, LegioNixx.

**Buffer storage tank in a cooling system**

**Solution No 17**

For heat insulation in cooling applications, a suitable, diffusion-tight heat insulation must be provided on-site.

To avoid condensation on the expansion lines, the pressure must be maintained in the warmer medium. Due to the load case at higher temperatures, the dew point is usually exceeded.

The diagram is only meant to illustrate the interconnections. Installation must be adapted to suit local conditions and specified in more detail.



# Reflex added values

## Excellent design software: Reflex Pro



### Powerful Reflex Pro family

Four versions of the powerful Reflex Pro family for designing, dimensioning and offer preparation are available free of charge at [www.reflex-winkelmann.com/en/software](http://www.reflex-winkelmann.com/en/software) Reflex Pro Win—PC download for convenient use of all features, even without an internet connection. Reflex Pro Web—online version that always accesses the latest data stock and can supply results in PDF format for downloading, for example. The design software was developed for pressure maintenance, water make-up and degassing systems and for heat transfer facilities in various areas of modern building and supply technology.

### Customised for use by professional craftsmen on site

Quick and reliable—the Reflex Pro app is always there to help you and ideal for mobile storage of projects and for initial consultations and solutions. Enter just a few facility parameters to perform calculations. The app is self-explanatory and easy to use. This digital tool helps improve efficiency. Easy to use and self-explanatory—for tablets and smartphones that use either Apple or Android operating systems.

Customised planning with the Reflex Pro calculation

[www.reflex-winkelmann.com/en/software](http://www.reflex-winkelmann.com/en/software)



## Practical digital sales support: the Reflex website

### Everything you need to know for your day-to-day work

On [www.reflex-winkelmann.com](http://www.reflex-winkelmann.com) you will find a host of information to simplify your offer preparation, expand your technical expertise and support you quickly and easily in your day-to-day business:

- News
- Contact details, names of people who can help you, service telephone numbers
- Convenient product search
- Product literature, instructions for installation and use
- Tender texts
- 2-D and 3-D product drawings, BIM data (Revit format)
- Standards and certificates

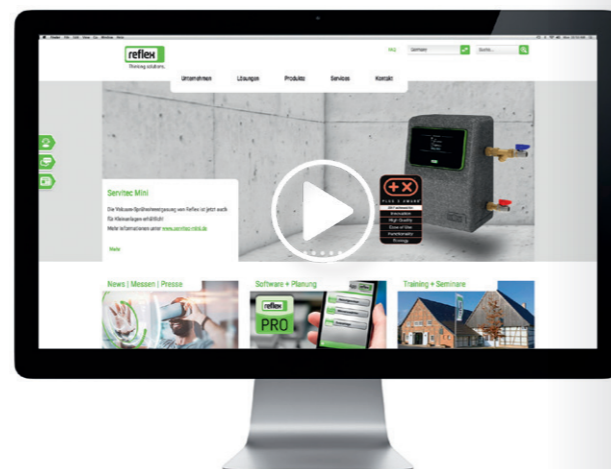

## Advantages through expertise: Reflex training

Contact the training team

+49 2382 7069 9581  
seminare@reflex.de

### Reflex Training—Expertise gives us the edge

Close to our headquarters in Ahlen, professional craftsmen, planners and operators gear up to face the challenges posed by heating and hot water supply in modern building technology. From installation to planning, from consulting to technical operation, the Reflex Training Centre and its team aligns its programme to those partners who want to learn more about technology, standards and service from the horse's mouth. Newly acquired expertise is put into practice, trained and experienced straight away on Reflex facilities in a former manor house that has been refurbished to modern standards in the German region of Westphalia. Realistic simulations and a comprehensive portfolio of facilities help to put the content learned to practical use; theory and practice are effectively



combined. The venue represents a perfect symbiosis of traditional and high-tech—the building, ambiance and equipment speak for themselves and provide a haven for successful learning far removed from hectic everyday life.

## The Reflex factory service—Right where you need it

Even once you have decided to invest in one of our products and made your purchase, you'll always be in good, experienced hands with Reflex. Whether it's the initial commissioning, ongoing maintenance and upkeep, or our repair and spare parts service, our responsive factory service centre is at your disposal throughout Germany to provide support at every step of the way. As for the Reflex commissioning service, this involves monitoring the installation process to ensure professional results, programming the system, and providing operator training on request. Thanks to our specialist expertise and qualifications, you can always stay on top of regular maintenance work and statutory audits. Furthermore, you can expect to receive comprehensive information on all legal requirements and obligations from us as a manufacturer. Our con-



sultancy and inspection service for pressurised systems operates in line with the latest Industrial Safety Regulations for Germany (BetrSichV) and you will receive qualified documentation and monitoring of all inspection intervals every time you make use of the service.

Factory service  
+49 2382 7069-9505  
aftersales@reflex.de



Technical hotline  
+49 2382 7069-9546  
aftersales@reflex.de



Commercial service  
+49 2382 7069-7505  
aftersales@reflex.de

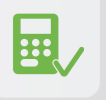

## List of abbreviations

### Terms and definitions

SO	Tank (top)
SM	Tank (middle)
SU	Tank (bottom)
WW	Hot water
KW	Cold water
ZI	Circulation
HT	High temperature
NT	Low temperature

### Components

PLP	Pump, primary charging station
PLS	Pump, secondary charging station
PFW	Pump, fresh water
PHK	Pump, heating circuit
PKO	Pump, collector
PSL	Pump, tank charging
PSW	Pump, swimming pool
PZI	Pump, circulation
VUR	Change-over valve with return flow boost
VUS	Change-over valve, solar or swimming pool
MHK	Mixer heater
PFK	Pump, solid fuel boiler
MAG	Expansion vessel

### Sensors and signals

SAT	Sensor, outside temperature
SBE	Sensor, service water heater
SFK	Sensor, solid fuel boiler
SFB	Sensor, fresh water
SHV	Sensor, heating flow
SHR	Sensor, heating return flow
SKE	Sensor, boiler (general)
SKO	Sensor, collector
SPK	Sensor, pellet boiler
SSM	Sensor, tank (middle)
SSO	Sensor, tank (top)
SSR	Sensor, solar return flow
SSU	Sensor, tank (bottom)
SSV	Sensor, solar flow
SSW	Sensor, swimming pool
SUR	Sensor, change-over valve with return flow boost
SWA	Sensor, heat exchanger outlet
SWE	Sensor, heat exchanger inlet
SZI	Sensor, circulation
DZI	Flow, circulation
TZI	Probe, circulation

### Pipelines

HV	Heating flow
HR	Heating return flow
SV	Solar flow
SR	Solar return flow
KV	Boiler flow
KR	Boiler return flow

## Performance charts

The following figures and information explain how to read the performance diagrams in the technical data

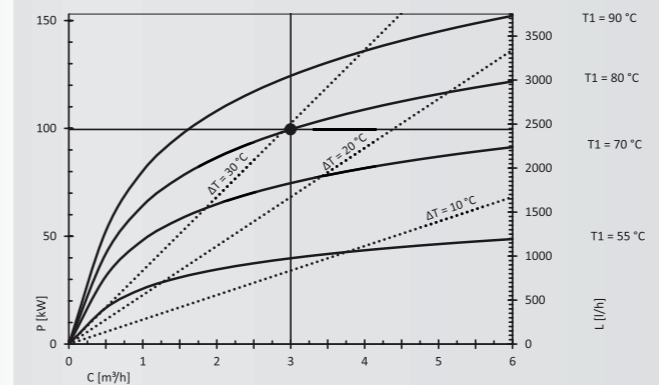

The curves show the performance history of the tank at the various supply temperatures. 55–90 °C. A curve can be interpolated between existing ones if a different temperature is required.

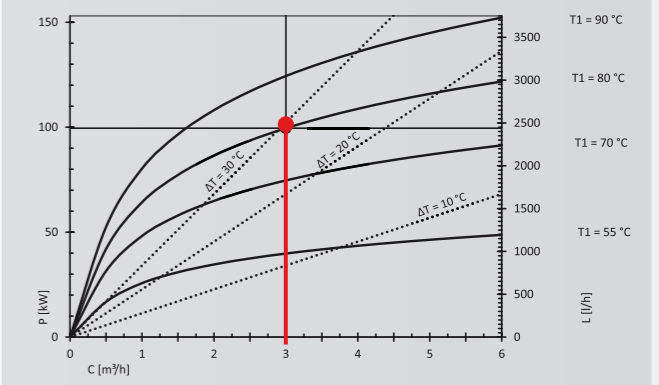

In combination with the flow rate 'C' in the heating registers, this results in an intersection point on the performance curve (X axis projected upwards). Dimensioning according to the standard is always 80 °C flow at a flow rate of C = 3.0 m³. The assumed temperature at the tap is always 45 °C.

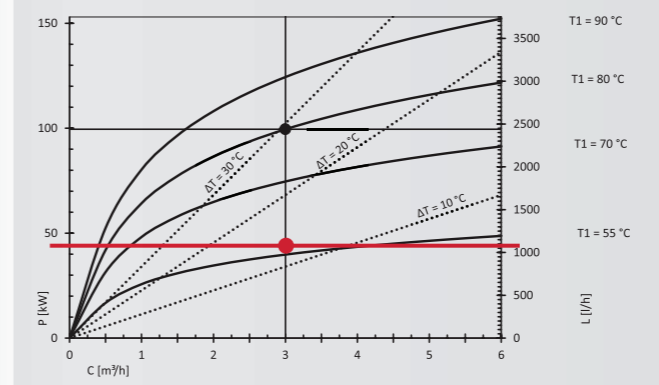

Extending the intersection point in the direction of the Y axes delivers the litre output on the right-hand side and the kW output required for this on the left-hand side.

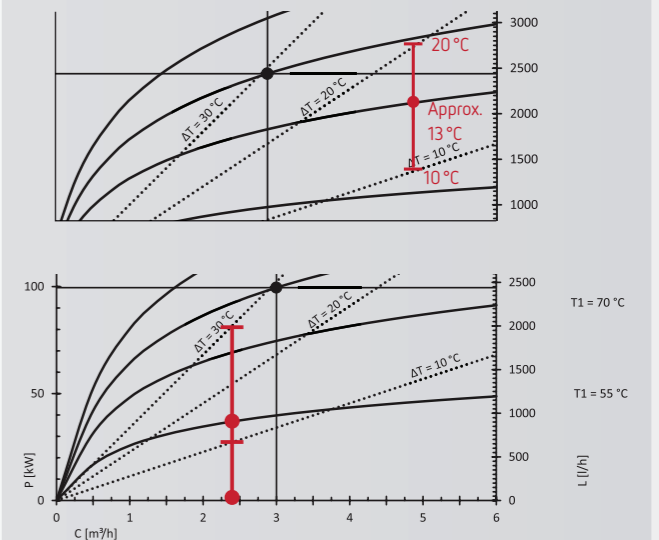

In addition, the resulting temperature difference between flow and return flow of the heating coil can be read out. On the other hand, the flow rate can be deduced from a known spread.

## Always up to date



Further product literature and materials can be downloaded at [www.reflex-winkelmann.com/en/services-downloads/](http://www.reflex-winkelmann.com/en/services-downloads/) or hard copies ordered from:

Experience our Reflex solutions for major facilities using augmented reality.



1 Scan QR code:  
[reflex.de/en/city](http://reflex.de/en/city)



2 Download the  
Reflex Smart City app



3 Scan the title of this brochure  
and explore

RE1882en / 9127855 / 04-20 / 2.000  
Subject to technical modifications



Thinking solutions.

Reflex Winkelmann GmbH  
Gersteinstraße 19  
D-59227 Ahlen

Telephone: +49 2382 7069-0  
Technical Service: [aftersales@reflex.de](mailto:aftersales@reflex.de)