

# Ferrolli

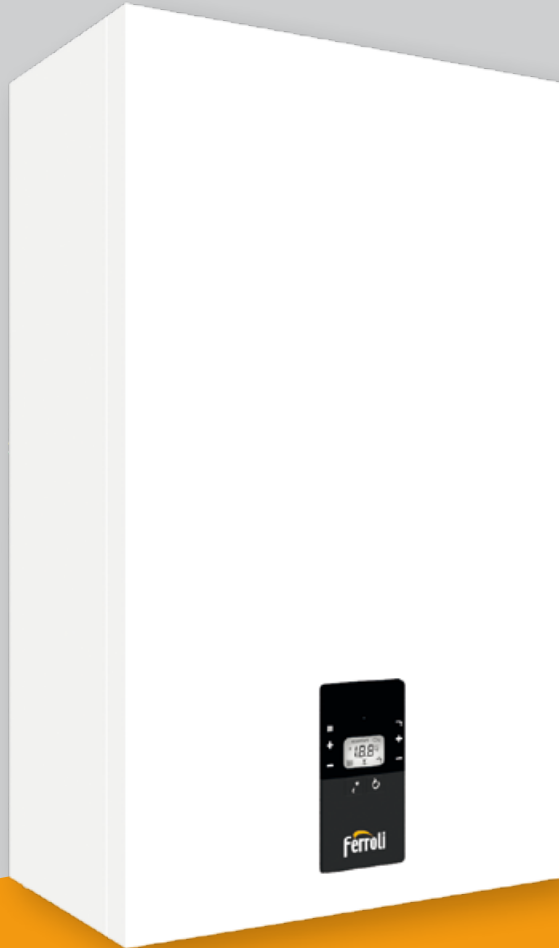

**H<sub>2</sub>**  
HYDROGEN  
PLUG-IN

## Bluehelix Alpha

Wall hung condensing boilers with instantaneous domestic hot water production



# BLUEHELIX ALPHA

... nicer than "PRIMA"

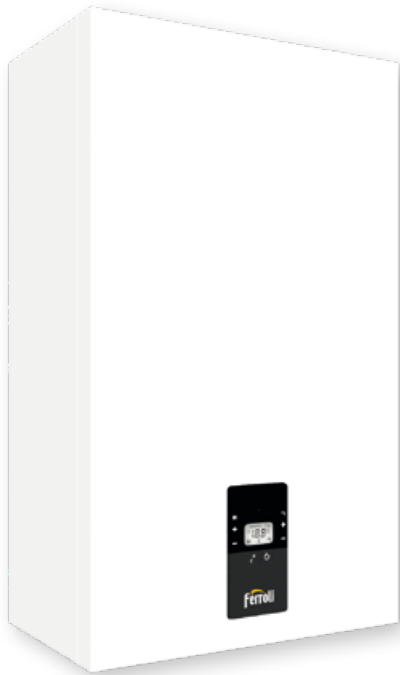

The new range of generators is equipped with the tested stainless steel heat exchanger. Designed and built according to the new ErP directives for eco-friendly design and labelling, BLUEHELIX ALPHA is the top in its category.

## THE RANGE

models operating with natural gas, LPG and propane air.

### mod. 24 C

COMBINED (14 l/min at  $\Delta t$  25°C)

### mod. 28 C

16 l/min at  $\Delta t$  25°C)

### mod. 34 C

(19.5 l/min at  $\Delta t$  25°C)

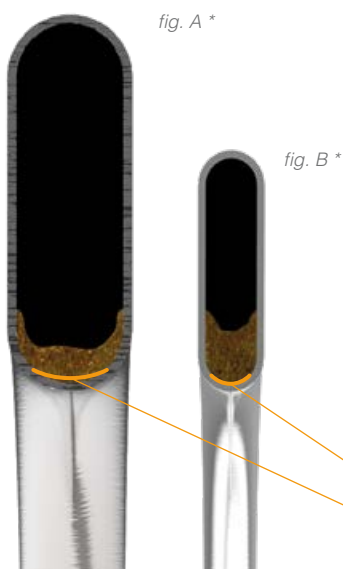

## TOP EFFICIENCY ALSO ON OLD SYSTEMS (REPLACEMENTS)

The BLUEHELIX ALPHA (**fig. A**) thermal unit heat exchanger compared to the more classic and popular steel exchanger (**fig. B**).

This shape enables the heat exchanger to work at almost maximum design efficiency, even in partially clogged conditions, whereas with the same amount of deposits and sediment (e.g. due to installation on old systems), the heat exchanger in **fig. B** tends to get clogged more quickly in the part in contact with the flame as a result of the reduced fluid flow area, where an actual barrier of deposits \* forms obstructing the heat exchange and reducing the efficiency to below nominal values.

\* Ref.: same amount (5 gr.) of scaling and deposits in heat exchanger (A) and (B), with the same pipe length section. Scale 150% of the actual measurement.



# CHARACTERISTICS

## Product benefits

- > Boiler with single-circuit stainless steel primary exchanger without joints and/or welding, it maintains high efficiency even in old systems.
- > **MC<sup>2</sup>: Multi Combustion Control**, new combustion system with gas-adaptive patented technology of industrial origin for better adaptability of use to the varying gas mains conditions (e.g. pressure fluctuations or drops)
- > **M.L.R.: Methane, LPG, Propane-air Ready** with a simple configuration the boiler can run on methane, LPG and propane-air without using additional conversion kits
- > **Instantaneous production** of domestic hot water with a **dedicated** DHW plate exchanger
- > User interface with display and multi-purpose keys to adjust and set the parameters
- > **Bypass as per standard**
- > **Solar system set-up:** set up for the production of domestic hot water combined with solar panel systems
- > **Flue ducting:** particularly suitable for operation in flues requiring "heavy duty" pipes thanks to approval for operation with 50mm diameter flue outlets.
- > **Minimum polluting emissions** (class 6 according to EN 15502-1)
- > **Sliding temperature operating mode** through outdoor probe (optional)
- > **Low consumption modulating** circulator (ErP Ready - Class A)
- >  : (for **mod. 28C** and **34C**) combined with the modulating remote control CONNECT, it reaches the top efficiency class A+ (scale from G to A+++)
- > User interface with display and multi-purpose keys to adjust and set the parameters
- > **Digital flame control** with three ignition attempts if operation gets blocked due to failed flame detection (methane mod.)
- > **Place of installation:** also outdoors, in a partially protected place down to -5°C as per standard and even -15°C with the addition of the optional antifreeze heaters kit
- > Removable **casing** into three pieces for easier maintenance or inspection.
- > **F.P.S.: Flue gas Protection System.** The optional flue gas accessory (041106X0 - Exhaust gas check valve kit), which can be installed outside the boiler, allows an easy connection to pressurised collective flue systems (e.g. in restructuring), in accordance with the UNI 7129 standard. **NOTE:** the kit cannot be used in recessed installations.

## THE PRODUCT IN BRIEF



Operating with **natural gas mixtures enriched with hydrogen** already provided for distribution in Europe (\*)  
 (\*) mixtures of Natural Gas/Hydrogen 80%/20%



Operation in a **partially protected location** with a minimum temperature of **-5°C for the standard version** and, if fitted with the antifreeze kit, even temperatures down to **-15°C**



The appliance can be combined with **preheating** systems for **domestic hot water**



Device operating with **climatic control** and sliding system temperature (optional outdoor temperature probe)



**Stainless steel** high performance mono-thermal **primary exchanger**



**MC<sup>2</sup>: Multi Combustion Control**, new combustion system with patented "Gas-adaptive" technology



**F.P.S.: Flue gas Protection System.** Installing the **specific flue gas non-return kit (optional)** allows an **easy connection to pressurised collective flue systems** (e.g. in restructuring), in accordance with the UNI 7129 standard.



**Remote control** of boiler parameters via remote control



**M.L.R.: Methane LPG Propane-air Ready**, with a simple configuration, the boiler can run on methane or LPG without using additional conversion kits



Approved for operation with **50mm diameter flue gas discharge**



This equipment is designed specifically to offer **particularly simple** installation and maintenance

# VIEW INSIDE BLUEHELIX ALPHA

## Main components

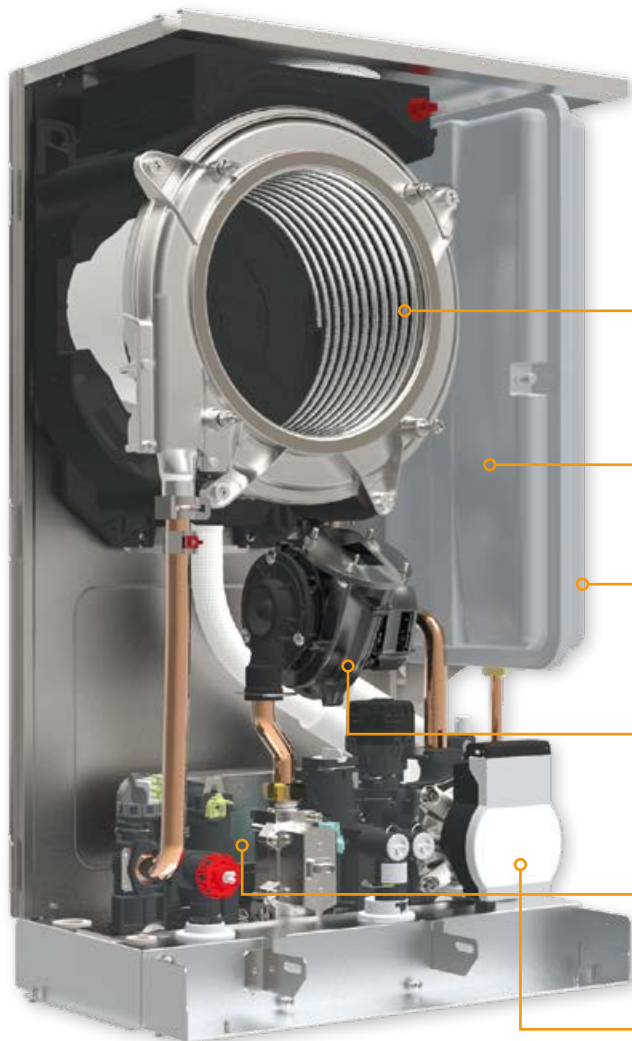

The design of **BLUEHELIX ALPHA** was focused on maximising its **functional benefits** and **construction sturdiness**, as well as enabling **simple maintenance**. All main components can be easily accessed, thus minimising the time required for routine maintenance.

### EXCHANGER

Stainless **steel high-pass single-circuit**, exchanger, clog-resistant and easy to clean

### STEEL FRAME

Made with high precision automated processes

### EXPANSION VESSEL

Incorporates an **8-litre expansion vessel** at the side

### FAN

Offset fan, to make **maintenance on the primary heat exchanger easier without disassembly**

### DOMESTIC HOT WATER HEAT EXCHANGER

Made of stainless steel, with copper brazing

### CIRCULATOR

High efficiency, for heating and exchange with the DHW circuit

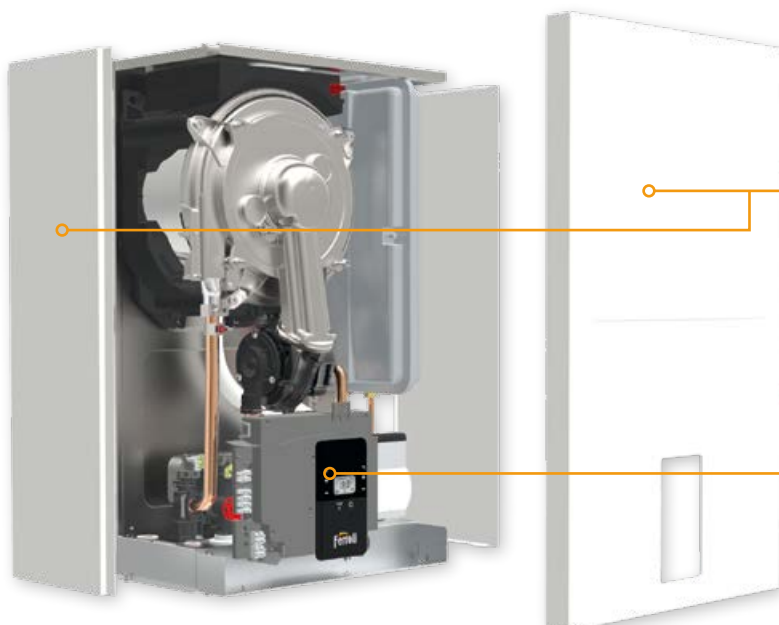

### SEALED CHAMBER

**Removable steel panel** to protect the combustion chamber with sealed chamber function

### ELECTRIC PANEL

Large **removable electric panel** as protection against any damage caused by water that may be used during normal maintenance.  
Easy access to electrical connectors.

# THE MOTOR

## Combustion chamber

The pipe used in the BLUEHELIX ALPHA heat exchanger is made of **stainless steel**, a material that creates an **extremely smooth surface**, thereby less affected by scaling and deposits.

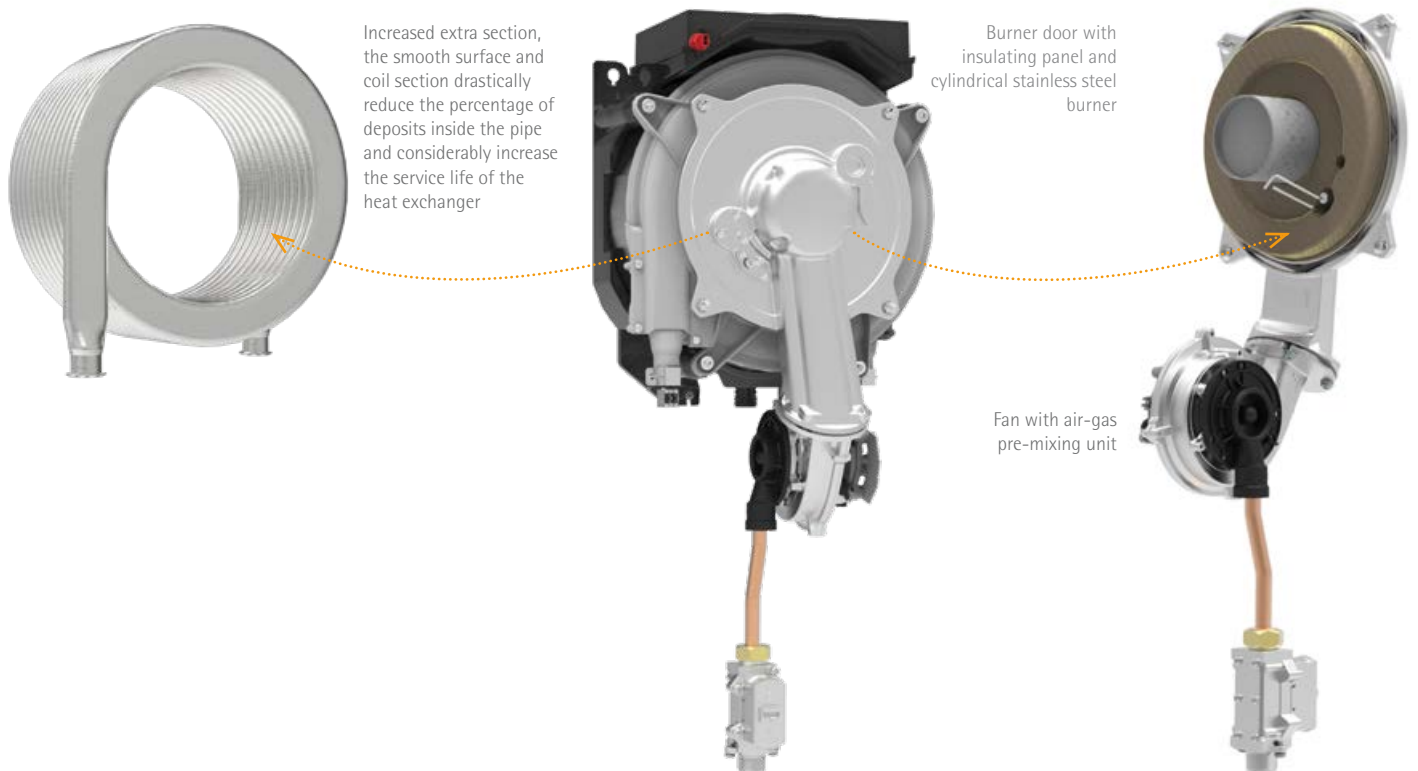

# BOILER CONTROL

## Control board and functions



The **BLUEHELIX ALPHA** control unit consists of an easy-to-use interface with a **backlit display**. The buttons allow you to easily adjust the heating delivery temperature and the domestic hot water setpoint, switch the generator on/off or activate the comfort function, while monitoring the boiler status. The control panel is complete with a traditional pressure gauge that can control the system pressure at any time.

**1-2** DHW temperature control **3-4** Heating system temperature control **6** Reset button - Sliding Temperature Menu **7** "Winter", "Summer", "Appliance OFF", "ECO", "COMFORT" mode selection key **8** Eco (Economy) or Comfort mode symbol **9** DHW symbol **10** Winter mode symbol **12** Multifunction symbol **13** Heating symbol **14a** Burner ON symbol (flashing during calibration and self-diagnosis phases) **14b** Appears when a fault is triggered and the appliance is blocked. To reset device operation, press RESET (part. 6) **17** Outdoor sensor detected (with optional outdoor probe)



# MC<sup>2</sup>

## Multi Combustion Control

The electronic device controls the flame ionisation current in order to ensure **perfect combustion** according to the change in air density or gas quality. The ratio between the air/gas flow ( $\lambda$ ) and the flame ionisation signal is used to control the air-gas ratio and, therefore, combustion. **MC<sup>2</sup>: Multi Combustion Control**, the new combustion system with **Gas-adaptive** patented technology for better adaptability of use to the varying gas mains conditions (e.g. pressure fluctuations or drops).

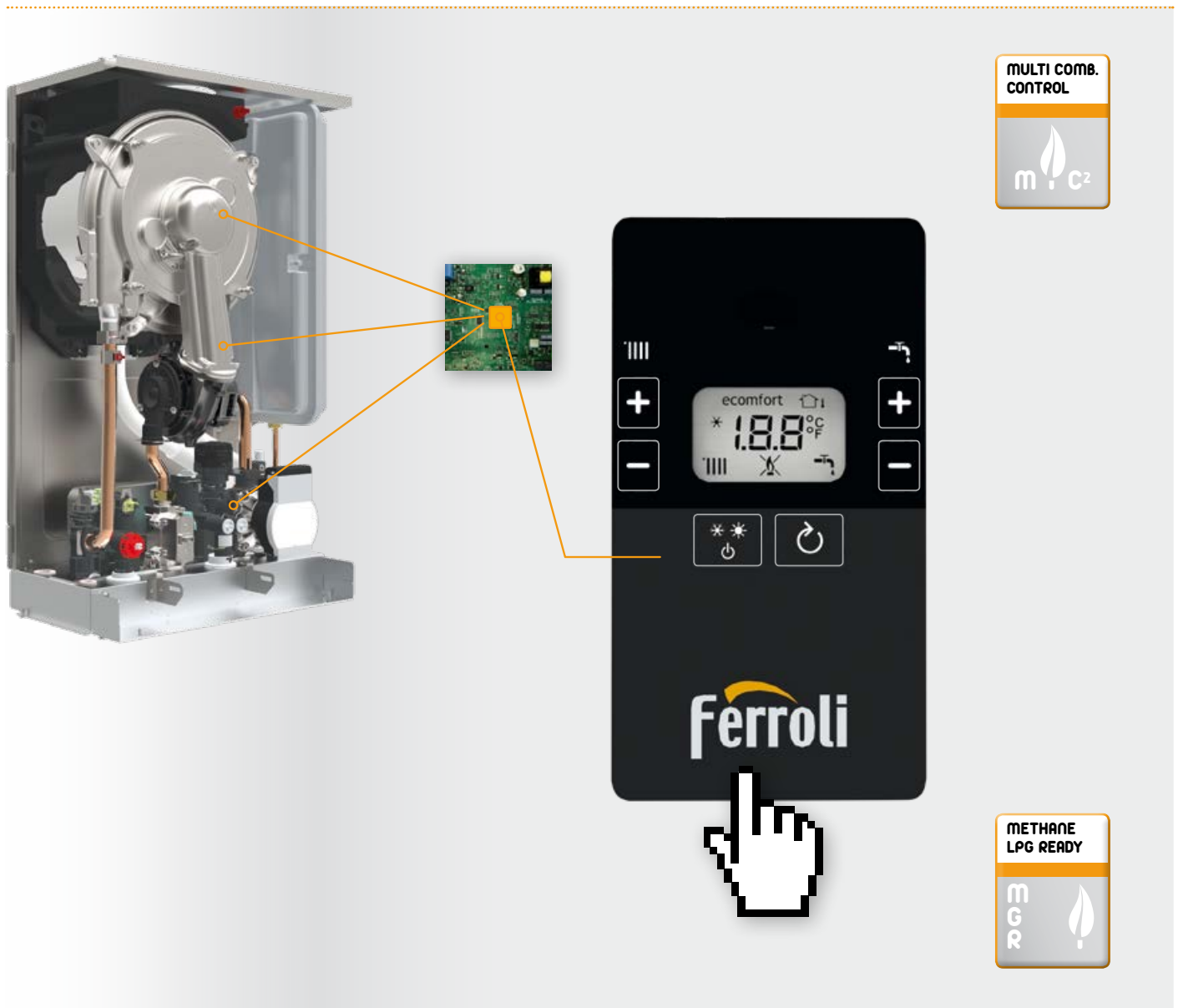

# MLR

## Methane, LPG, Propane-air Ready

Thanks to the **new electronics**, **gas exchange is extremely simple**.

The MC<sup>2</sup> combustion control monitors the quality of combustion constantly and by simply modifying an electronic board parameter (operation to be carried out by qualified staff only), it is possible to operate the boiler with Natural gas, LPG or Propane-air.

**The additional accessories kit does not need to be purchased.**





# CONNECT

The new remote control



Control



RF/Wi-Fi receiver

**New wireless remote control** available as an accessory to manage **comfort in the home** also from a **Smartphone with the Connect App (iOS and Android)**. Maximises the ambient comfort by modulating the delivery temperature via the **Ambient Climatic Compensation (ACC)** and **Outdoor Climatic Compensation (OCC)** functions by means of the **outdoor temperature that can be measured directly via the Internet** (or an optional outdoor probe). It can manage **until 8 zones** by additional control units. **Improves ambient heating seasonal average efficiency by +4%.**

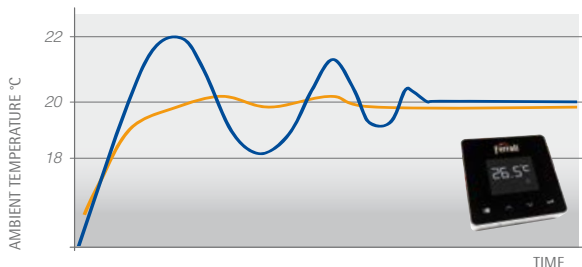
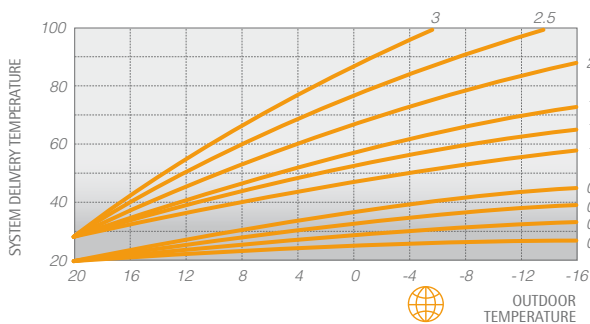

## OCC WEB | OUTDOOR AIR CLIMATIC COMPENSATION

By reading the outdoor temperature directly from the Internet (or from the optional outdoor probe), the system can change the temperature based on the outdoor temperature measured according to the climatic curves set, thus ensuring maximum user ambient comfort as the outdoor climate conditions change.

## ACC AMBIENT CLIMATIC COMPENSATION

The modulating function of CONNECT allows the boiler's **power to be modulated** as the **value of the set room temperature** is reached. This improves the quality of comfort by eliminating heat peaks with consequent energy savings.

WITH CONNECT REMOTE CONTROL TIMER

WITH NON-MODULATING AMBIENT THERMOSTAT

# EASY MAINTENANCE

Problem-free maintenance

When servicing the device for the first time, technicians can appreciate the care with which each part has been designed to facilitate their work. As a result of easy access to the main components, the BLUEHELIX ALPHA thermal unit enables maximum accuracy and fast maintenance.

A few examples:

- The electric box of the electronic board can be easily removed from the chassis, giving **free access to the internal parts**.
- Easy access to the burner unit by removing the 4 screws and **quick coupling (clip) of the fan**.
- The **extra-increased pass heat exchanger** is designed to challenge extremely hard water conditions and can be **easily cleaned** thanks to the non-manifold single pipe circuit.
- The DHW **inlet filter** can be easily **removed** directly from the inside, **without having to remove the boiler water connections**.
- Disassembly and **replacement of the plate heat exchanger** is carried out easily **by removing the two hex bolts** that can be accessed from the front





# COMFORT AND SAFETY

## Functions

The designers have considered a set of functions that are able to guarantee the quality of DHW, the best power supply to the heating system as well as a longer service life of the device.

### SUN EASY FUNCTION

BLUEHELIX ALPHA was designed to be installed easily into systems built with the most innovative technologies. The SUN EASY system is equipped with electronics that **simplify operation with solar panels**, both with natural and forced circulation. A sensor situated on the DHW circuit constantly controls the pre-heated water temperature from the solar panels, providing burner ignition only if the said temperature drops below the level required to ensure optimal user comfort.

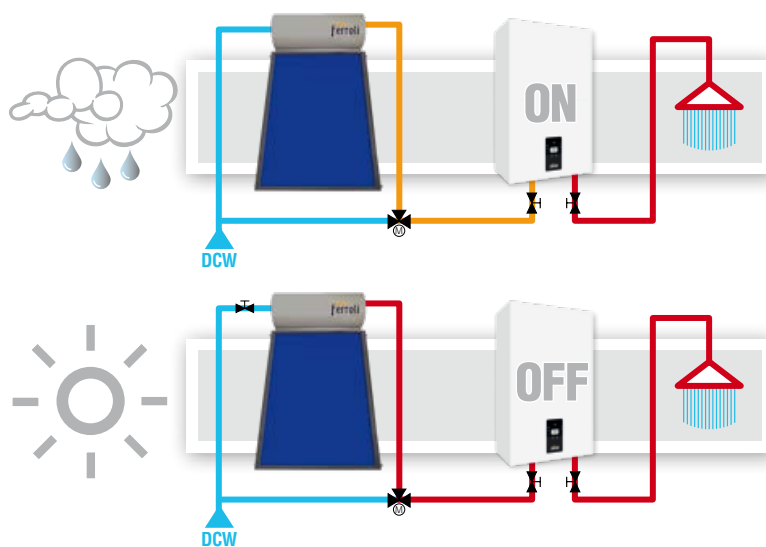

In case of insufficient irradiation and therefore the domestic hot water being modestly pre-heated, the boiler will contribute with the necessary heat to reach the required setpoint temperature.

If the sun and the solar system fulfil their "duty", no integration from the boiler will be necessary; the hot water will be conveyed to the tap, without additional devices being required, with the mixing of the thermostatic valves.

### STOP AND GO FUNCTION

The use of DHW taps with short mixing or very short supply for quick rinses involves boiler ignition procedure start-ups, which usually end immediately. These **"false start-ups"** can, over time, compromise the average service life of the product. For this reason, BLUEHELIX ALPHA has been equipped with an electronic parameter that is used to delay burner ignition (Stop and Go) by only activating it with actual DHW delivery.



### OUTDOOR INSTALLATION - ANTIFREEZE FUNCTION

To make maximum use of the spaces available, BLUEHELIX ALPHA 24C / 28C can be recessed into the wall using a special kit. For more complicated installations in fully exposed areas that are not protected against harsh weather conditions, a "painted cabinet" kit is also available. If the boiler temperature drops to 5°C, the burner automatically turns on and the circulator is activated in order to **protect the device from damage caused by frost**. This function is active with the boiler supplied by the gas circuit and live.



With wall hung cabinet kit



With recessed casing kit

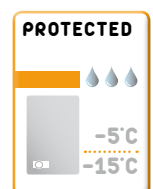

### DHW ECO-COMFORT FUNCTION

With ECO operation, DHW production is provided according to traditional standards, enabling energy saving when it is not used. As a result of the special temperature maintenance of the heat exchanger, **DHW supply is even faster and more comfortable** with COMFORT operation. The efficiency and load profiles according to the ErP directive are at the top of the category: **mod. 24 C / A - XL**.





# SIMPLIFIED REPLACEMENT

Flue exhaust  $\varnothing$  50 mm

The new boiler can also be installed with 50 mm diameter outlets.

Particularly important in the **replacement market** in the frequent case of collective flues that require “heavy” **pipes**, where it is necessary to have a **high flue gas ejection capacity** also with small diameters.

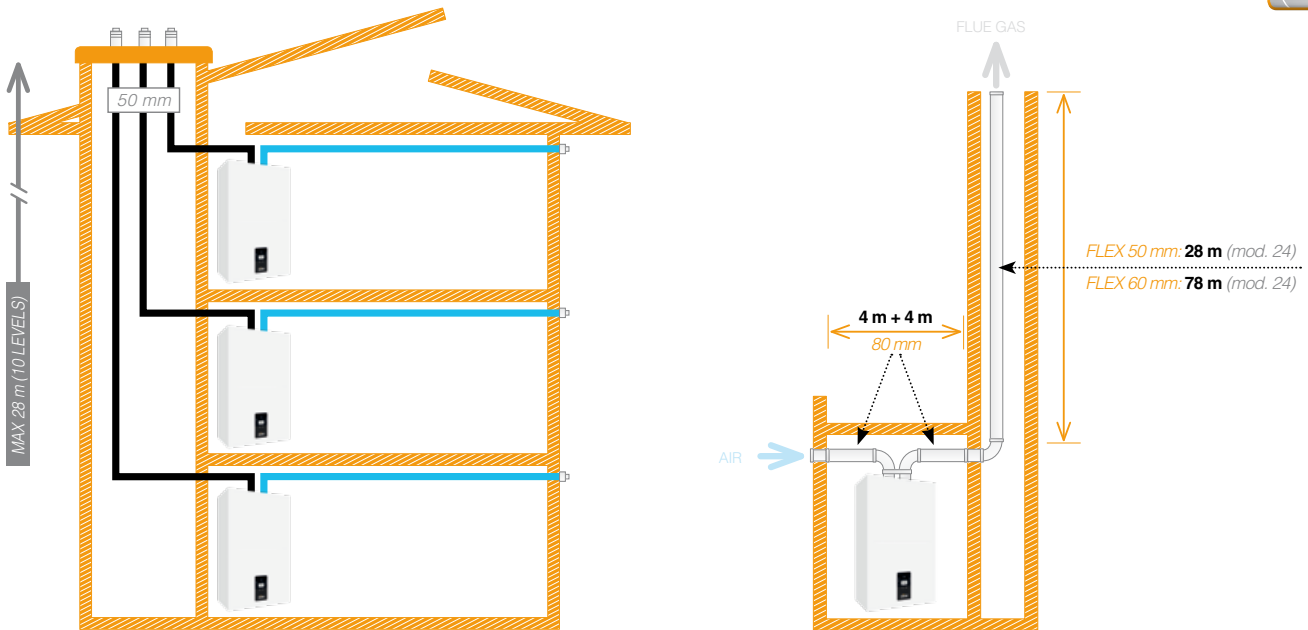
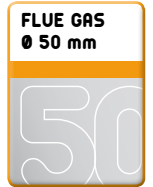

## Collective pressurised

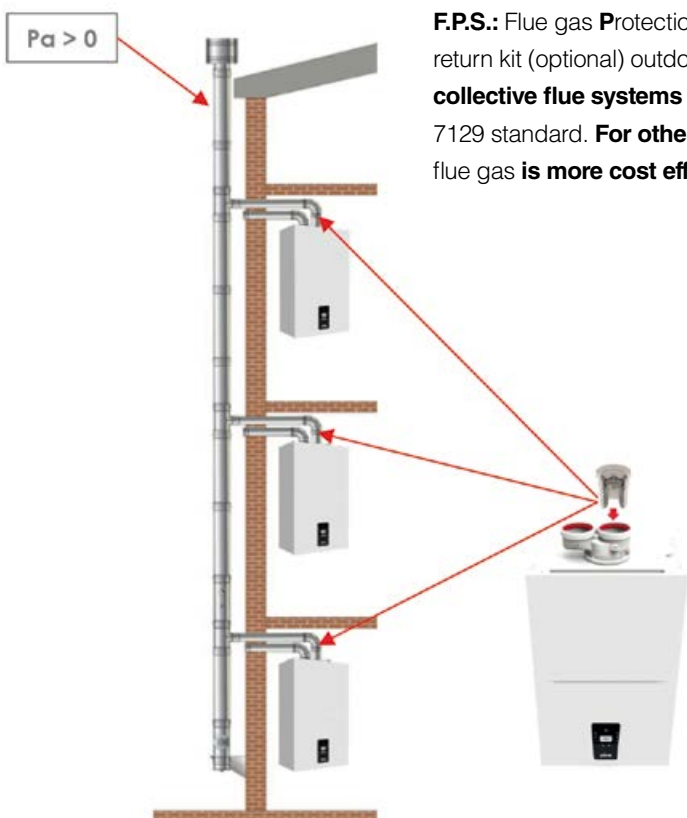

**F.P.S.:** Flue gas Protection System). Installing the specific flue gas non-return kit (optional) outdoors, allows an **easy connection to pressurised collective flue systems** (e.g. in restructuring), in accordance with the UNI 7129 standard. **For other installers**, the solution of pressurised collective flue gas **is more cost effective** (decrease in the diameter of the chimneys).





# CHARACTERISTICS

## Hydraulics - Energy label

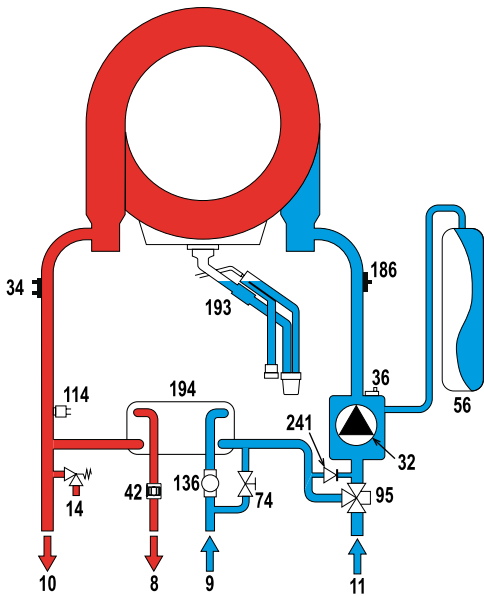

**KEY**

- 8 DHW water outlet
- 9 DHW inlet
- 10 System delivery
- 11 System return
- 14 Safety valve
- 32 Heating circulator
- 34 Heating temperature sensor
- 36 Automatic air vent
- 42 DHW temperature sensor
- 56 Expansion vessel
- 74 System filling valve
- 95 Diverter valve
- 114 Water pressure switch
- 136 Flowmeter
- 186 Return sensor
- 193 Siphon
- 194 DHW heat exchanger
- 241 Automatic bypass (inside the pump unit)

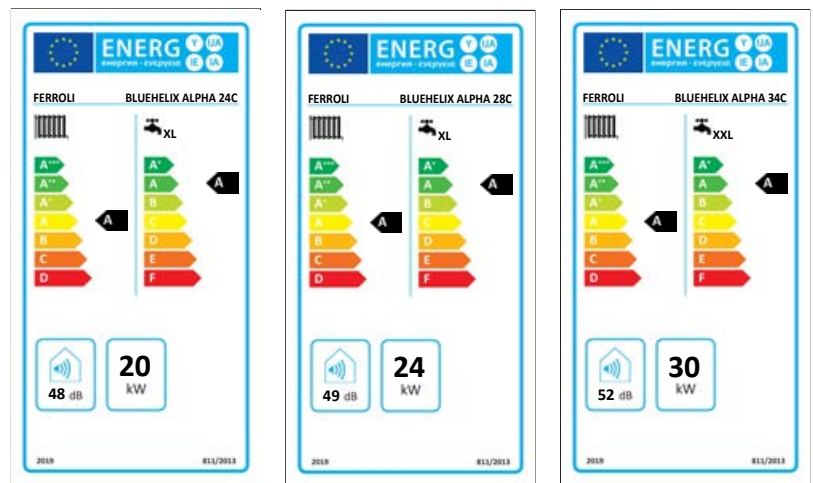

# TECHNICAL DATA

## Dimensions and flue fittings height

BLUEHELIX ALPHA 24 C - 28 C

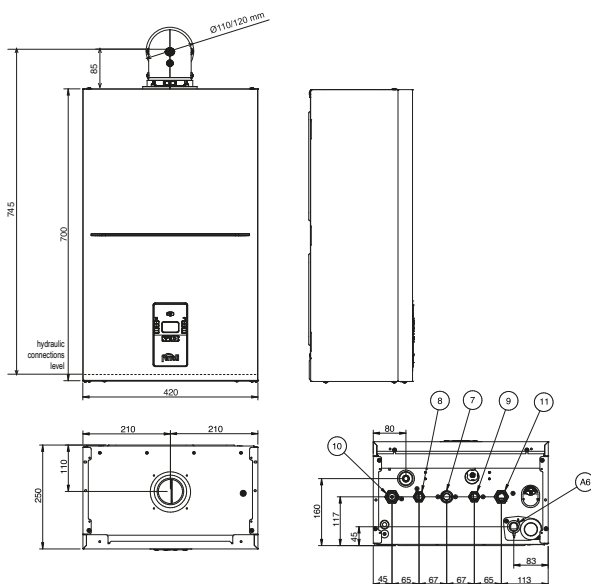

BLUEHELIX ALPHA 34 C

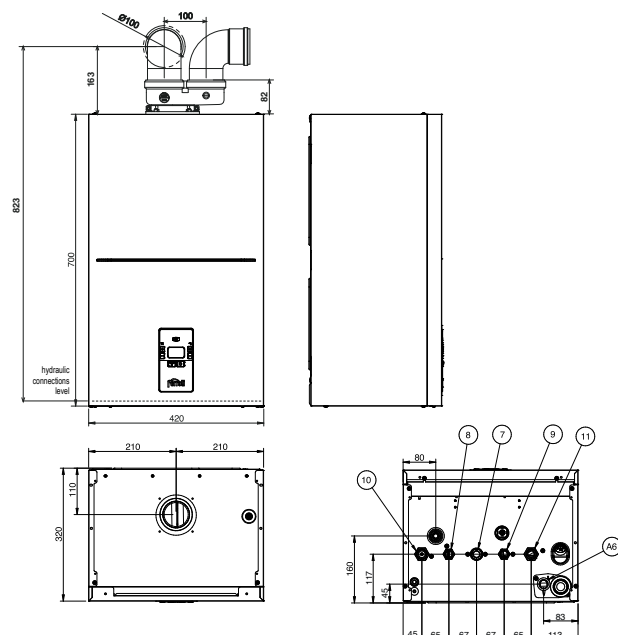

**KEY** - 7 3/4" gas inlet 8 1/2" DHW outlet 9 1/2" DHW inlet 10 3/4" System delivery 11 3/4" System return A6 Condensate discharge



# TECHNICAL DATA

## Summary table - Residual head

BLUEHELIX ALPHA			24 C	28 C	34 C
ERP Class		(Class G - A <sup>++</sup> )			
		(Class G - A)			
Heating max / min heat input	kW		20.6 / 4.2	24.5 / 4.8	30.7 / 5.0
Heating max / min heat output (80/60°C)	kW		20 / 4.1	24 / 4.7	30 / 4.8
Heating max / min heat output (50/30°C)	kW		21.8 / 4.5	26 / 5.0	31.9 / 5.4
DHW max heat input	kW		25	28.5	34.8
DHW min heat input	kW		4.2	4.8	5.0
DHW max / min heat output	kW		24.3 / 4.1	28.0 / 4.8	34.0 / 4.8
Pmax efficiency (80-60°C)	%		97.1	97.8	97.7
Pmin efficiency (80-60°C)	%		97.0	97.6	97.2
Pmax efficiency (50-30°C)	%		105.8	106.1	106.2
Pmin efficiency (50-30°C)	%		106.9	107.3	107.1
Efficiency 30%	%		108.8	109.7	109.7
G20 supply gas pressure	mbar		20	20	20
G20 max gas flow rate	m³/h		2.65	3.02	3.68
G20 min gas flow rate	m³/h		0.44	0.51	0.53
CO <sub>2</sub> max / min G20	%		9.0±0.8	9.0±0.8	9.0±0.8
G31 supply gas pressure	mbar		37	37	37
G31 max / min gas flow rate	kg/h		1.94 / 0.33	2.21 / 0.37	2.70 / 0.39
CO <sub>2</sub> max / min G31	%		10.0±0.8	10.0±0.8	10.0±0.8
NO <sub>x</sub> emission class (EN 15502-1)	-		6	6	6
Max heating working pressure	bar		3	3	3
Min heating working pressure	bar		0.8	0.8	0.8
Max heating temperature	°C		95	95	95
Heating water content	litres		3.0	3.4	4.3
Heating expansion vessel capacity	litres		8	8	10
Heating expansion vessel preload pressure	bar		0.8	0.8	0.8
DHW max working pressure	bar		9	9	9
DHW min working pressure	bar		0.3	0.3	0.3
DHW flow rate Δt 25°C	l/min		14	16.1	19.5
DHW flow rate Δt 30°C	l/min		11.7	13.4	16.2
Protection rating (IEC 60529)	IP		IPX4D	IPX4D	IPX4D
Supply voltage	V/Hz		230V / 50Hz	230V / 50Hz	230V / 50Hz
Absorbed electric power	W		73	82	99
Empty weight	kg		27	27	31

### EFFECTIVE HEAD AVAILABLE TO THE SYSTEM

BLUEHELIX ALPHA 24 C - 28 C

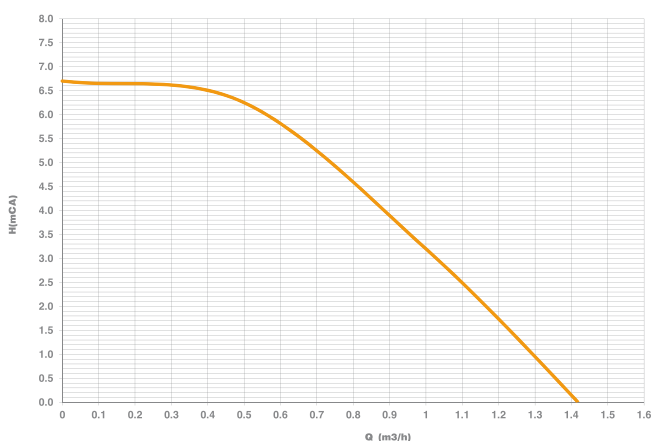

BLUEHELIX ALPHA 34 C

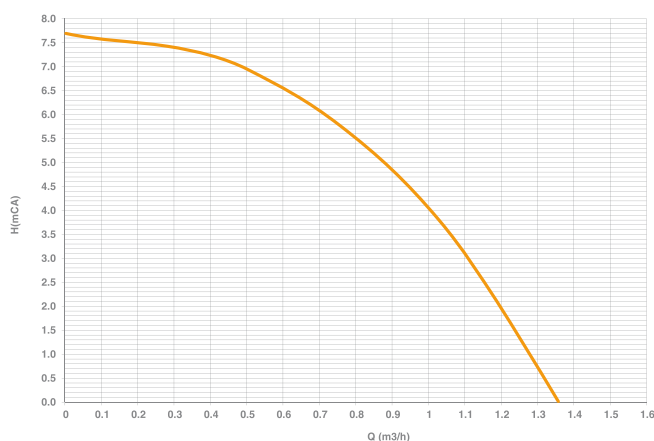



**NOTICE FOR SALES AGENTS:**

With a view to constantly improve its production range and customer satisfaction levels, the Company hereby specifies that aesthetic and/or dimensional features, specifications and accessories may be subject to changes.

Please place the utmost care to ensure all technical and/or sales documents (lists, catalogues, brochures, etc.) provided to the final Customer are updated according to the latest edition.

**Ferroli SpA**

37047 San Bonifacio (VR) Italy - Via Ritonda 78/A

tel. +39.045.6139411

fax +39.045.6100233

[www.ferroli.com](http://www.ferroli.com)

[export@ferroli.com](mailto:export@ferroli.com)